

FLUKE®

Reliability

VIBXPERT® EX

Short instructions

db® PRÜFTECHNIK



VIBXPERT[®] EX

**FFT data collector and
signal analyzer with intrinsic safety**

Short instructions



Version 2.3x
Edition January 2017
LIT 53.101.EN

LEGAL NOTES

Copyright

Both this manual and the product it describes are copyrighted. All rights belong to the publisher. The manual may not be copied, reproduced, translated or made accessible to a third party in any form, neither in its entirety nor as an excerpt.

Disclaimer

No liability may be claimed against the publisher regarding the product described in this manual. The publisher assumes no liability for accuracy of the manual contents. Furthermore, under no circumstances may the publisher be held liable for direct or indirect damage of any kind resulting from use of the product or the manual, even if the publisher has expressly indicated the potential for occurrence of such damage.

The publisher assumes no liability for any product defects. This warranty and liability limitation applies to all distributors and sales partners as well.

Trademarks

The trademarks mentioned in this manual are generally noted as such and are the property of their owners. Lack of such designation does not imply, however, that names are not protected by trademark laws.

© Fluke Corporation, all rights reserved

Contents

Contents.....	3
About this manual	3
Safety notes	4
Conformity	4
Interface parameters for VIBXPERT EX	5
Description	6
Overview.....	6
Keyboard	7
LED display.....	8
Power supply	9
Connection to the PC.....	10
Operation	12
Basic operating functions	12
Examples for typical operation procedures.....	13
Off-route measurement ('Multimode').....	16
Route measurement.....	18
Measuring with a machine template	20
Measuring a route with VIBCODE.....	22

About this manual

This short instruction manual is intended to provide a handy day-to-day reference for the most important functions of the instrument and basic program operation procedures.

For truly complete information, however, the full-length operating manual (VIB 9.805.G) contains detailed explanations of all functional features as well as considerable background information on condition monitoring.

The operation of the optional 'Balancing' module is described in the 'Balancing' operating manual (VIB 9.806.G).

Both documents are stored as a PDF file on the supplied storage medium.

Safety notes



The following applies in **potentially explosive environments**:

- For vibration measurements, you may only use
 - > LineDrive transducers of the VIB 6.1xx DEX model series
 - > VIBCODE transducers (VIB 8.660 HEX)
- Under no circumstances may you take measurements with the following sensors:
 - > TIPTECTOR hand-held probe,
 - > LineDrive transducers of the VIB 6.1xx EX model series
 - > LineDrive transducers of the VIB 6.1xx REX model series.
- The connection cable for extra-low signal current (VIB 5.434) and extra-low signal voltage (VIB 5.433) may not be used with VIBXPERT EX.
- Under no circumstances should you recharge the battery.
- Under no circumstances should you use the VIBXPERT case (VIB 5.329 X).
- The protective film must be removed from the display.

How to deal with rechargeable batteries

- Charge the battery only outside the EX area.
- Do not send devices with defective battery by air freight.
- Defective batteries may only be replaced by authorized PRÜFTECHNIK personnel.

Also observe the safety notes in the operating manual.

Conformity

The product complies with the relevant European directives. The declaration of conformity is available as a PDF and may be downloaded from the PRÜFTECHNIK homepage at:

www.pruftechnik.com/com/Know-How/Media-Center/Certificates-and-Material-Safety

Interface parameters for VIBXPRT EX

Analog output circuit

In type of protection intrinsic safety Ex ib IIC, only suitable for the connection to devices intended for this

$$\begin{array}{lll} U_o = 28V & C_i = 54nF & L_i = 300\mu H \\ I_o = 63mA & C_o = 83nF & L_o = 7mH \\ P_o = 300mW & & \end{array}$$

The sensors of the VIB 6.1***DEX model series can also be connected to this interface. The sensors of the VIB 6.1***EX model series should not be connected to this interface.

Temperature sensor circuit

In type of protection intrinsic safety Ex ib IIC, only suitable for the connection to NiCr-Ni-thermocouple

$$\begin{array}{ll} U_o = 6V & C_o = 40\mu F \\ I_o = 6mA & L_o = 0.8H \\ P_o = 8mW & \end{array}$$

Digital output circuit

in type of protection intrinsic safety Ex ib IIC only suitable for the connection to devices intended for this

$$\begin{array}{ll} U_o = 12V & C_o = 1,41\mu F \\ I_o = 188mA & L_o = 0.8mH \\ P_o = 600mW & \end{array}$$

LAN/USB circuit

Do not use this interface in an explosive environment! Only devices with $V_m < 6V$ or the communication adapter for VIBXPRT EX (order no. VIB 5.330 UNV) may be connected for data transmission purposes.

Battery load circuit

Do not use this interface in an explosive environment!
To charge the batteries, use charger VIB 5.322-INT only!

Description

Overview

① **Keyboard:** suitable for right-hand/ left-hand operation. The keys and the joystick can be comfortably operated with the thumb.

② **Light sensor** controls key board illumination.

③ **LEDs** indicate:

- Alarm condition
- Measurement error
- Battery charge status.

④ **Display** - large, backlit, high-contrast.

⑤ **Channel A / B** measure analog sensor signals.

⑥ **Temperature** - interface for thermo couple type K

⑦ **Digital input / analog output** for:

- Trigger / RPM sensor
- Data transfer via RS 232
- Headphone / Oscilloscope
- Stroboscope control

⑧ **Charging socket**

⑨ **Communication/ printer**
Connect PC / printer via universal communication adapter VIB 5.330-UNV.

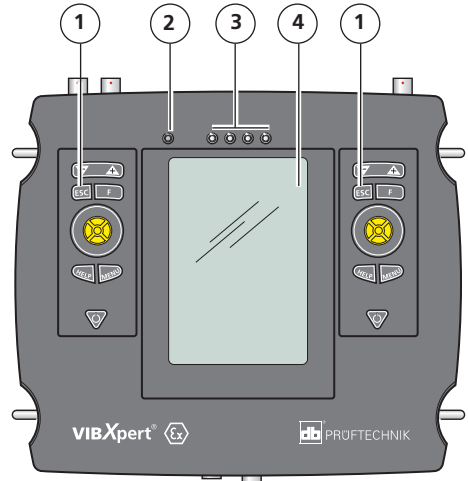

Top view

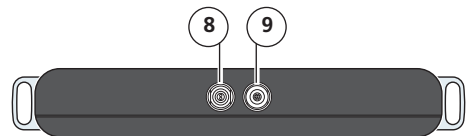

Bottom view

Keyboard

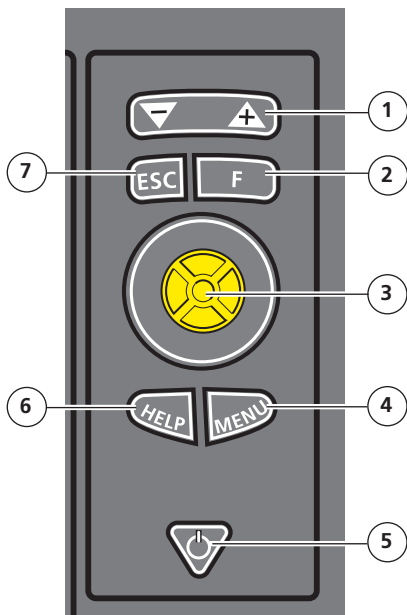

①

Rocker key +/- :

- Zoom for X axis
- Change tab

②

F key:

- special functions such as tab, fast menu, search,...

③

Joystick:

- Navigation
- ENTER

④

MENU key:

- Menu functions (context-sensitive)

⑤

On/Off key:

- Switch on
- Switch off
- Restart ('Reset')

⑥

HELP key:

- Help page

⑦

ESC key:

- Cancel
- Return
- Switch off (in the start screen)

LED display

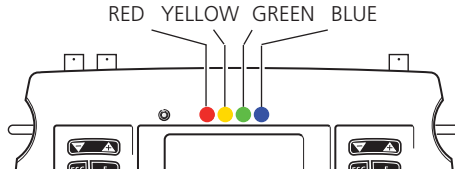

Status and alarm indication

LED	RED ●	YELLOW ●	GREEN ●	BLUE ●
constant	Alarm	Warning	Prewarning	Meas. OK
flashing	Signal overload, Battery empty	Signal unstable	Trigger signal	Battery almost empty

Flashing LEDs have the higher priority.

Examples:

Signal overloads and exceeds the alarm level => RED flashes.

Signal unstable and exceeds the alarm level => YELLOW flashes.

Battery status during charging

LED	RED ●	YELLOW ●	GREEN ●	BLUE ●
constant	Error	Battery charging	Battery full	---

Power supply

The rechargeable battery is permanently installed in the housing and can be charged using the VIBXPERT EX charger (VIB 5.322-INT). The residual charge of the battery is displayed in the battery icon.



Battery full



Battery half empty

Battery icon

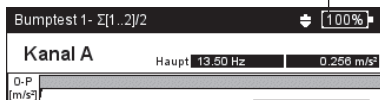

Charge the battery only outside the EX area.
Permissible charging temperature: 0°C to 50°C.



Attention!

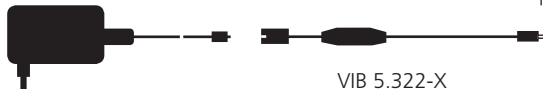
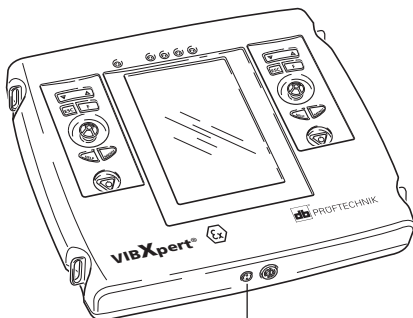

VIB 5.322-X

VIB 5.322-INT

VIBXPERT EX charger (VIB 5.322-INT) =
Standard charger (ALI 50.651) + connection adapter (VIB 5.322-X)

Connection to the PC

A PC or Laptop must be connected to VIBXPERT EX via the universal communication adapter (VIB 5.330 UNV).



Attention!

Do not use the adapter in a potentially explosive environment!

Direct connection to the PC / laptop

Serial

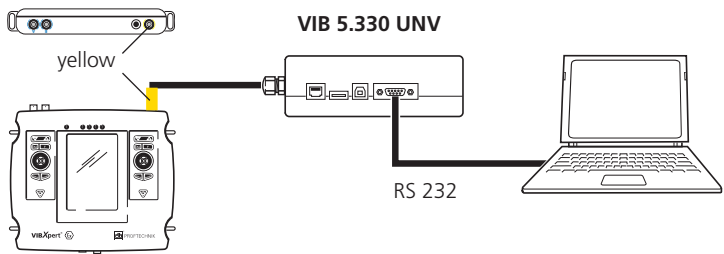

USB

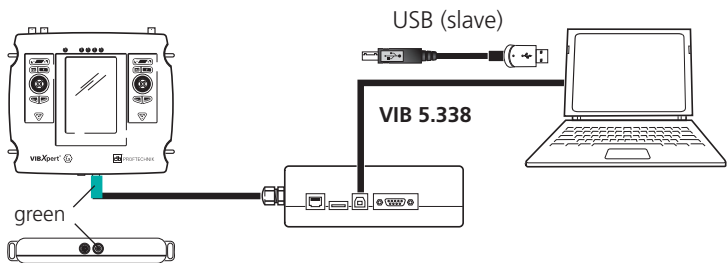

Patch

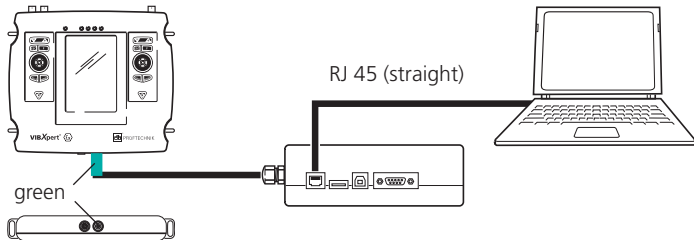

Connecting the PC / laptop via a network

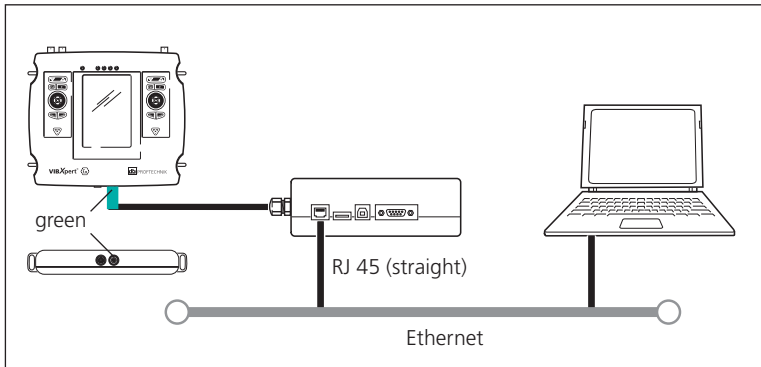

Operation

Basic operating functions



Switching on, switching off,
resetting VIBXPRT.

Switching on:

- Hold the key down for 2 seconds.
- The start screen appears after approx. 30 seconds.

Switching off:

- Hold the key down for 2 seconds.
- Confirm the query to switch off with 'YES'.

Resetting:

- Hold the key down for 5 seconds until the device switches off and restarts.



Navigation:
Move the cursor in the screen
and select an element.

- The joystick can be shifted in vertical or horizontal direction respectively.



Confirm selection
with ENTER.

- Press (click) the joystick.



Open the 'Menu'.

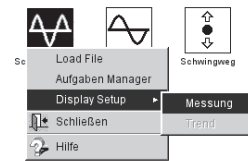

The functions of the current
program section are found in the
'Menu'



Cancel operation and close
current screen.

- Only in the start screen:
Switch off device.

Examples for typical operation procedures

Example 1: How to change the setting in a field



Select the respective field.

Aufgabe—

user ▾

—Messkanal—

Kanal A Kanal B

Black frame



Confirm with ENTER.

Aufgabe—

user ▾

—Messkanal—

Kanal A Kanal B

Grey frame (edit mode)



Select new setting.

Aufgabe—

user ▾

—Messkanal—

Kanal A Kanal B

Selection has dotted frame.



Confirm with ENTER.

Aufgabe—

user ▾

—Messkanal—

Kanal A Kanal B

The Edit mode is closed. The cursor can be moved over the entire screen again.

Example 2: How to navigate in a tree view (Route, File manager, ...)

	Select a tree node in the same hierarchy.	
--	---	--

	Open the parent node and show the child nodes.	
--	--	--

Example 3: How to enter numbers (Time, Date, IP address, ...)

	Select the respective field.	
--	------------------------------	--

	Enter Edit mode.	
--	------------------	--

	Increase / decrease value.	
--	----------------------------	--

	Select next value.	
--	--------------------	--

	Increase / decrease value.	
--	----------------------------	--

	Confirm changes and exit edit mode.	
--	-------------------------------------	--

Example 4: How to enter a text (name, comment, ...)

 Select the respective character.

- Changing character table -> 0.1
- Deleting text -> 0.2
- Special characters (, + /) are not allowed in a file name

USB1					
A	B	C	D	E	F
G	H	I	J	K	L
M	N	O	P	Q	R
S	T	U	V	W	X
Y	Z	0	1	2	3
4	5	6	7	8	9
.	,	-	_	←	↵

Backspace 'key'

 Confirm selection, and enter the next character.

U					
A	B	C	D	E	F
G	H	I	J	K	L

  Finally save the text.

OK
Exit
Tables ▶
Caps lock

0.1 Changing character table:



0.2 Deleting text:

- Position the cursor in the text field.
- Delete the character left to the cursor with the Backspace 'key'





Note

Off-route measurement ('Multimode')

 Switch on VIBXPRT.

- see section 'Basic operating functions'.

 Start 'Multimode'.



Multimode

 Open tab for overall, signal or advanced measurements.



 Select measurement icon.

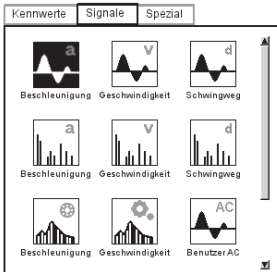

- Changing the meas. task -> 1.1
- New / edit task -> 1.2
- Connecting the sensor -> 1.3

 Start measurement with ENTER.

- Sensor connection is checked, if sensor detection is enabled.
- Green LED is flashing during meas: Trigger OK.
- Blue LED lights up after the meas.: Measurement OK.
- Live mode: Keep the joystick pressed when the measurement starts.
- Repeating the measurement -> 1.4

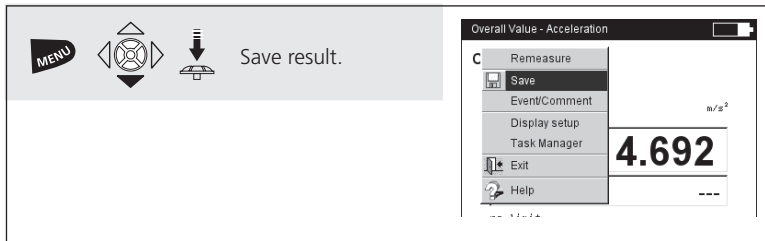

<p>1.1 Changing the measurement task:</p>		 Note
<p>1.2 New task / edit task:</p>		
<p>1.3 Sensor and measurement channel are displayed in the info field.</p>		
<p>1.4 Repeating the measurement: Press ENTER twice, if safety note appears.</p>		

Route measurement



Switch on VIBXPRT.

- see section 'Basic operating functions'.



Start 'Route' mode.





Select route.

Route	Fertig
Demo route	0/8
test	0/4
vxp	0/8

- Route contains no VIBCODE location.



Select measurement location.

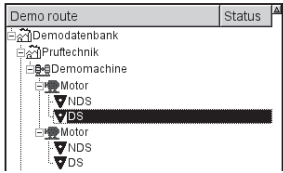

- Change view: tree or list -> 2.1
- No meas. location in tree view visible? -> 2.2
- Skip route element -> 2.3



Select measurement icon.

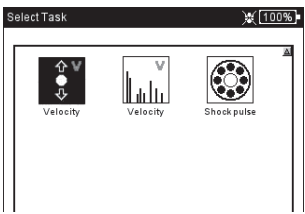

- Reference measurement must be carried out first.
- Skip task -> 2.3
- Connecting the sensor -> 1.3



Start measurement with ENTER.

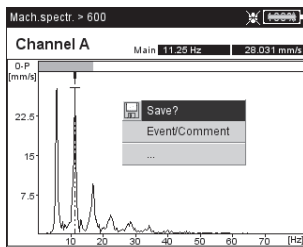

- Meas. tasks with the same sensor are performed automatically one after the other.
- Results are saved automatically, if 'AutoSave' is enabled (-> 2.4).
- 'Route is finished' appears, if all measurements have been completed.

2.1 Route view mode:



Note

2.2 Show meas. locations in tree view:

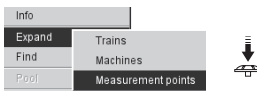

2.3 Skip element (considered to be completed):

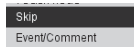

2.4 AutoSave:

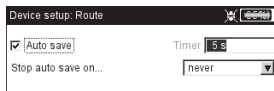



Measuring with a machine template



Switch on VIBXPRT.



- see section 'Basic operating functions'.

Start 'Machine template' mode.



M. template





Select machine template.

Select machine template [ESC]

Machine Template	Dor
DEMO	--/5
--test	0/5
Demomaschine	--/5
Gear template	--/5
Gear template with multtask	--/5
Pump KSB XYZe	--/4
--01232005	1/4
--01232005	4/4
Template Pump	--/4
gus	--/1

- Machines where measurements have already been carried out appear subordinate to the associated template.

Click on 'Details' and enter the necessary machine data.



Select machine template [ESC]

Machine Template	Dor
Bomba Agua Alimentacion 2A (BFWP-2A)	--/7
--Machin 1	0/7

Machine description

Machine Name	OK
Machine 3	Exit
Customer	Details
Model	
Road number	

- Click on OK, if you only want to accept the recommended name.





Save machine description.

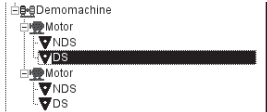



ACME Inc.	OK
Modell	Schließen
MT 1234	Details
Nummer	

 <p>Select measurement location.</p>	 <p>A machine template is set up like a route and resembles a route in operation and workflow.</p>
---	---

 <p>Select measurement icon.</p>	<ul style="list-style-type: none"> • see section 'Route'. • Connecting the sensor -> 1.3
---	---

 <p>Start measurement with ENTER.</p>	<ul style="list-style-type: none"> • see section 'Route'.
--	--

Measuring a route with VIBCODE

	<p>Switch on VIBXPRT.</p> <ul style="list-style-type: none"> • see section 'Basic operating functions'. 								
	<p>Start 'Route' mode.</p>  <p>Route</p>								
	<p>Select route.</p> <table border="1" data-bbox="717 568 997 652"> <thead> <tr> <th>Route</th> <th>Fertig</th> </tr> </thead> <tbody> <tr> <td>Demo route</td> <td>0/8</td> </tr> <tr> <td>test</td> <td>0/4</td> </tr> <tr> <td>vsp</td> <td>0/8</td> </tr> </tbody> </table>	Route	Fertig	Demo route	0/8	test	0/4	vsp	0/8
Route	Fertig								
Demo route	0/8								
test	0/4								
vsp	0/8								
<p>Connect the VIBCODE transducer to the VIBCODE measurement location.</p>	 <ul style="list-style-type: none"> • Measurements start automatically, if the location is found in the route. • If the meas. location is in the VIBCODE pool: First measurement starts automatically, all other measurements must be triggered manually with the joystick. 								



Faithful companion

VIBSCANNER® is the ideal partner for your daily measuring and inspection rounds. Integrated transducers record all important machine signals. Process parameters can be supplied as analog signals or entered manually. A checklist of visual inspection tasks, e.g. "Check oil level", assists in tracing faults. FFT and balancing is also included. Graphic user guidance and intuitive joystick navigation make operating child's play.

VIBSCANNER® – Machine evaluation, data collection & balancing



Ultra-modern

The third generation of ROTALIGN® now benefits from a backlit color screen and alphanumeric backlit keyboard. Its comprehensive and straightforward features makes laser alignment of even the most complex applications simple to perform. The ROTALIGN® Ultra computer has a high performance processor, providing fast data processing.

ROTALIGN® Ultra – The ultimate alignment system



You better move on

VIBROWEB® XP is a compact monitoring and diagnostic system for production-critical or process-critical special machines:

- ⊗ Extruders
- ⊗ Process ventilators
- ⊗ Special drives
- ⊗ Remote pumping stations
- ⊗ Emergency power supplies (UPS)

VIBROWEB® XP – Diagnostic Online Condition Monitoring

Printed in Germany LIT 53.101.EN.01.2017

Fluke Deutschland GmbH
 Freisinger Str. 34
 85737 Ismaning, Germany
 + 49 89 99616-0
 www.pruftechnik.com



Productive Maintenance Technology