

FLUKE®

Reliability

VIBXPERT® II Balancer

db® PRÜFTECHNIK

Operating instructions

VIBXPERT® II

Balancer

Vibration analysis
Field balancing
in 1 or 2 planes

Operating
Instructions

Series: VIB 5.310

Firmware version: 3.2x

Edition: December 2019

Order no.: LIT 53.203.EN

Translation of the german manual

LEGAL NOTES

Copyright

Both this manual and the product it describes are copyrighted. All rights belong to the publisher. The manual may not be copied, reproduced, translated or made accessible to a third party in any form, neither in its entirety nor as an excerpt.

Disclaimer

No liability may be claimed against the publisher regarding the product described in this manual. The publisher assumes no liability for accuracy of the manual contents. Furthermore, under no circumstances may the publisher be held liable for direct or indirect damage of any kind resulting from use of the product or the manual, even if the publisher has expressly indicated the potential for occurrence of such damage. The publisher assumes no liability for any product defects. This warranty and liability limitation applies to all distributors and sales partners as well.

Trademarks

The trademarks mentioned in this manual are generally noted as such and are the property of their owners. Lack of such designation does not imply, however, that names are not protected by trademark laws.

© Fluke Corporation, all rights reserved

Foreword

Congratulations! And thank you for choosing VIBXPERT II Balancer, one of the most powerful balancing and vibration analysis equipment from PRÜFTECHNIK.

This specially for field balancing designed instrument is based on the VIBXPERT II platform, which is used worldwide by many technicians for mobile data acquisition and signal analysis.

The 'Balancer' is distinguished by its efficiency and ease of use. The measurement process implemented in the instrument is based on the well-known "influencing coefficients method" and has been optimized by a new knowledge-based algorithm. In addition to the balancing procedure, VIBXPERT II allows vibration analyzes, resonance tests and phase measurements to support the diagnosis of an imbalance and to determine the optimum operating conditions for the rotor.

Application

- Field balancing in one or two planes
- Vibration analysis
- Resonance test

Analysis

- Overall value and process parameter
- Time waveform
- Amplitude spectrum
- Envelope spectrum (acceleration)
- Phase measurement, incl. recording
- Impact test (1-channel)
- Coast-down/ Run-up test (Phase, overalls)
- Frequency markers
- Signal post processing for time waveform (overalls)
- ISO standards for evaluation

Valuable additional benefits

- Saving reports on USB pen drive
- Robust carrying case
- Comprehensive accessories

Hardware

- Two synchronous measurement channels for balancing in two planes.
- Unlimited storage capacity (Standard: 2 GB CompactFlash).
- Dustproof and splashproof (IP65) - ideal for use in demanding industrial environments
- Connector for NiCrNi thermocouples
- Stroboscope control output

Ergonomics

- Large, backlit color display ensures clear data presentation and optimum readability
- Three alarm LEDs (red-yellow-green) indicate if thresholds have been exceeded (based on ISO standards).
- Daylight sensor controls keyboard illumination
- Easy-to-use keypad
- Graphical user interface
- Color-coded connectors
- Online, context-sensitive HELP

Power supply

- Lithium-Ion battery for more than 8 hours of operation
- Smart battery charging in VIBXPERT II.
- Automatic power management (display, device)

Communication

- Fully networkable
- PC connection via USB, Ethernet, RS232.

And if you want more from your Balancer ...

.... then upgrade to the VIBXPERT II FFT data collector and signal analyzer. Just enter the password!

VIBXPERT II Balancer* from PRÜFTECHNIK once again demonstrates the company's skills and innovative strength in the field of maintenance, and is a consistent advancement in the series of successful portable device systems such as VIBXPERT I, VIBSCANNER, VIBROCORD, VIBROTIP, VIBCODE.

Also, we would like to make you aware of the application-oriented seminars offered by PRÜFTECHNIK that feature a significant practical segment. They are very well received by course participants and you will find them to be a good investment.

Check with PRÜFTECHNIK or with your local distributor for availability and schedules. For further information, visit our website:

<http://www.pruftechnik.com>

And if you are ever faced with an unsolvable task, our specialists from the PRÜFTECHNIK Service and Diagnostic Center (SDIC) will be glad to assist you. Just send an e-mail:

service@pruftechnik.com

Contents

Chapter 1: Prior to starting	1-9
Safety and operating notes.....	1-10
Chapter 2: Getting started	2-1
Overview.....	2-1
Keyboard	2-2
Status display per LED.....	2-2
Notes on operation	2-3
Interfaces	2-5
Power supply.....	2-7
Charging the battery in the device.....	2-7
Charging in the external charging station	2-8
Carrying pouch - VIB 5.356	2-9
Belt	2-9
Hand strap	2-9
Memory card.....	2-10
Replacing the memory card	2-10
Basic settings - Device Setup	2-12
Date & Time	2-12
Display settings, switchoff and additional options	2-13
Transducers	2-14
Language	2-18
Registration	2-18
Units	2-19
Key controls	2-20
Printer	2-21
Service menu.....	2-23
Memory card (CF).....	2-25
Standardization factor for dB scaling.....	2-25
Deleting files	2-25
Data transfer	2-26
Direct connection to PC	2-26
Network connection	2-27
USB pen drive.....	2-27
Setting up the network communication	2-28
IP address of the local PC in the network	2-29
Entering a fix IP address for the local PC	2-29
Update.....	2-30
Chapter 3: Vibration analysis	3-1
Selecting the measurement task	3-1
What is a measurement task?	3-2
Measurement, Analysis, Diagnosis	3-3
Preparation.....	3-3
Starting a measurement:.....	3-3
Continuous measurement (live mode).....	3-3
Save result.....	3-4
Options before, during and after a measurement	3-5
Aborting a measurement	3-5
Repeating a measurement	3-5
Changing the measurement channel	3-5
Changing the sensor	3-5

Setting up a new measurement task	3-6
Creating a new setup	3-6
Entering an Event/Comment	3-14
Trend	3-15
Results	3-16
Result details	3-16
Characteristic overall value - single values	3-16
Characteristic overall values - trending	3-17
Time waveform	3-18
Amplitude / Envelope Spectrum	3-20
3D display of spectra: Waterfall diagram	3-23
Sound spectrum: third-octave and octave level diagram	3-25
Display Setup	3-27
Reports	3-30
Preparations for direct printing	3-30
Printing the content of a result screen	3-30
Measurement reports	3-31
Configuring the measurement report	3-31
Printing out the measurement report	3-32
Loading reports onto USB pen drive	3-33
Exporting measurement data in MS Excel format	3-34
Measurement tasks	3-35
Characteristic overall vibration values	3-35
RPM measurements	3-36
Temperature measurement	3-37
Runup / Coastdown	3-38
Envelope analysis	3-43
User-defined measurement quantities	3-43
Phase measurement	3-44
Impact test - 1 channel	3-45
Chapter 4: Balancing	4-1
Balancing on machines with rotating masses	4-2
Assembly	4-3
Measuring the initial imbalance	4-8
Trial run	4-8
Trim run	4-9
Undoing balancing runs	4-10
Overview of the measurement procedure	4-11
Determining the measurement plane & balancing plane A	4-11
Measuring the initial imbalance in plane A and plane B	4-11
Trial run	4-12
Trim run	4-12
Saving the result	4-12
1. Combining balancing weights	4-14
2. Changing the correction mode (Tools menu / Machine setup)	4-15
3. Removing the balancing weight (Tools menu/ Machine setup)	4-17
4. Check functions (Tools menu / Machine setup)	4-17
5. Entering the balancing radius and rotor mass later (Tools)	4-18
6. Speed for balance quality (Tools menu / Machine setup)	4-18
7. Influence coefficient (Tools menu)	4-18
Machine setup	4-22
Measurement setup	4-25
Operation of the balance calculator	4-28
Balancing quality classes	4-29

Chapter 5: Appendix.....	5-1
Numerical editor.....	5-1
Text Editor.....	5-2
File Manager.....	5-3
Functions of the MENU key.....	5-3
Printing out the PDF file.....	5-4
Transferring a PDF file on a USB pendrive.....	5-4
VIBXPRT utility.....	5-5
Installing and starting the program.....	5-5
Registering optional functions.....	5-6
Setting up a connection with VIBXPRT.....	5-7
Configuring VIBXPRT.....	5-7
Transferring files.....	5-8
Transferring system files.....	5-8
Technical notes.....	5-10
Storage.....	5-10
Cleaning.....	5-10
Maintenance.....	5-10
Guarantee.....	5-11
Spare parts, accessories.....	5-11
Disposal.....	5-11
Technical data.....	5-12
Troubleshooting.....	5-14
Reloading firmware.....	5-14
Index.....	5-16

Chapter 1: Prior to starting

On delivery, check the goods for damaged or missing parts. Note any possibly objectionable parts on the shipping documents and claim them with the forwarder or your local PRUFTECHNIK partner.

Service addresses

Feel free to contact us in case of questions:

Hotline: +49 89 99616-0

Service address:

Fluke Deutschland GmbH
Freisinger Str. 34,
85737 Ismaning, Deutschland

About this manual

VIBXPRT II Balancer is also referred to as 'VIBXPRT', 'Balancer' and 'device' in these operating instructions.

If you don't have this manual handy, open the online help in the device with the HELP key.

This manual is valid for Firmware Version 3.2x.

A circular icon with the word "HELP" inside, representing the help key on the device.

Safety and operating notes

Read this section carefully, paying especially close attention to the safety notes, before working with the device.

Symbols used



WARNING!

Danger to life and limb!



Attention!

Operating errors that can lead to data loss or equipment damage.



Note

Information and tips on operating the data collector.

Intended use

VIBXPERT may only be used for the measurement of machine signals in industrial environments while taking into consideration the technical specifications (see "Appendix - Technical data").

Transducers and cables may be used only for their respective intended uses as defined in the corresponding sales leaflets.

VIBXPERT is intended for use as a portable balancing device for the balancing of *stationary* machines equipped *solely with rotating components (rotors)*, e.g. turbine rotors, inductors, circulating pumps, centrifugal compressors, fans, etc. This does not include machines with oscillating components, e.g. all reciprocating machines.

VIBXPERT can be used without any restrictions for the balancing of rigid rotors. Elastic (soft) rotors may only be balanced with VIBXPERT at the resonant frequency ($\pm 25\%$) by an experienced user. The measurement instrument and its accessories may only be operated by authorized personnel.

Any other use shall not be considered an intended use and is impermissible. Incorrect or impermissible use and failure to observe the instructions in this manual result in a loss of warranty from PRÜFTECHNIK.



Conformity

The product complies with the relevant European directives. The declaration of conformity is available as a PDF and may be downloaded from the PRÜFTECHNIK homepage at:

www.pruftechnik.com/certificates



General safety

The following notes must be carefully read and completely understood before the device is put into service.

- The applicable safety regulations must be observed when performing measurements on running machines.
- Install the measurement equipment properly. During measurement on machines with rotating parts exposed, ensure that no brackets, cables can become caught in rotating machine parts.
- When assembling measurement components, make sure that no holders, cables, etc. project into the range of movement of rotating machine parts.
- The respective manufacturer's instructions must be followed when mounting balancing weights.
Make sure that attachment points for balancing weights to be welded on are clean; clamp the ground electrode of the welding device onto the rotor and not onto the machine.
For balancing weights that need to be screwed on, the maximum permitted RPM of the motor must be observed.
- The machine must be disconnected in order to work on the rotor and must be secured against being switched on again in accordance with the applicable regulations.
- Before the first measurement (initial run), ensure that the preparatory activities have been carried out correctly and completely. In addition to the assembly of measurement components, particular attention must be paid to the correct input of parameters in the machine setup. If an incorrect rotor mass is entered, a trial weight that is too large may be calculated as a result. This could have serious consequences for personnel and machine!
- No one is allowed to remain in the radial vicinity of the rotor during balancing runs. This area must be properly secured against unauthorized entry. If the trial weight of the rotor on a running machine detaches, there is a risk of fatal injury in this area!
- If the rotor is in a protective housing, any gaps in the housing must be closed before switching on the machine.
- The permitted switch-on frequency of the machine may not be exceeded. Otherwise, the motor could be damaged.
- The cause of the imbalance must be determined before balancing, and must be corrected if necessary (e.g. remove any caking on the rotor, weld any cracks on the impeller or replace the impeller).
- VIBXPERT may only be operated if it is undamaged, dry and clean.
- Operation and maintenance are to be performed only by properly trained personnel.
- Repairs to VIBXPERT may be carried out only by a PRÜFTECHNIK-authorized service technician.
- Only original spare parts and accessories may be used.
- Only properly functioning, regularly-maintained electrical equipment may be used. Any defects such as broken plugs or loose sockets must be corrected immediately. Damaged cables must be replaced by an authorized service technician.
- Any alterations that affect device design or operating safety are not permitted.

Environmental influences

- ◆ Portable radio-based devices can interfere with proper functioning of the device when operated nearby. In case of doubt, check the connecting cable between the device and its transducer.
- ◆ Avoid exposing the device, its transducers and cables to environmental conditions that exceed the tolerances listed in the ‘Technical Data’ section at the rear of this manual.
- ◆ Keep the protective caps on the connector sockets when they are not in use to keep them clean.

How to deal with rechargeable batteries

- Charge the battery only with the VIBXPERT charger.
- Maximum charge temperature: 40°C.
- Follow the safety instructions enclosed with the charger.
- Do not use damaged batteries!
- Do not use force to open the battery or throw it in the fire!
- Do not short-circuit connection contacts!
- Dispose of used batteries properly in accordance with regulations.
- Do not send devices with defective batteries by air freight.
- During extended periods of non-use and during storage, connect VIBXPERT regularly to the mains supply. This prevents the battery from becoming completely discharged, and the date and time settings are retained.

Nameplates

The diagram below shows the locations and the contents of the device nameplate and the battery nameplate (standard version).

Nameplate for the VIBXPERT device with serial number ('S.No.')

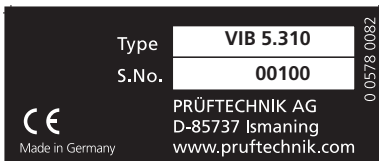

Nameplate for the rechargeable battery with serial number and safety notes

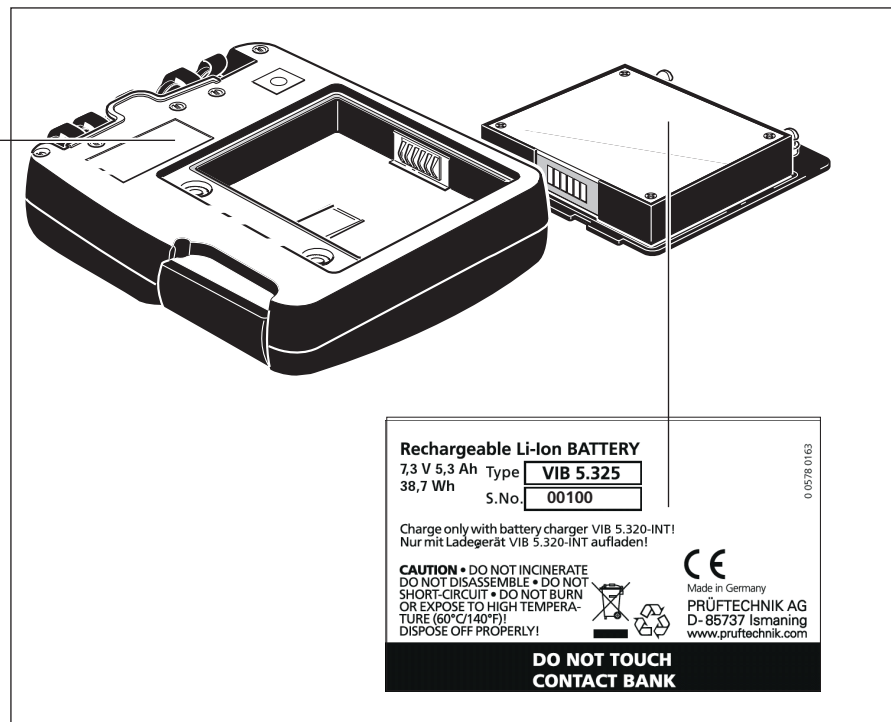

Chapter 2: Getting started

Overview

The illustrations show the interfaces and operating elements:

The diagram illustrates the VIBxpert II Balancer's interfaces and operating elements. The top image shows the front panel with callouts 1 through 7. The bottom image shows the rear panel with callouts 8 through 11.

- ① **Full color display** - large, backlit, high contrast.
- ② **Ambient light sensor** controls keyboard illumination.
- ③ Four **LEDs** indicate:
 - Alarm condition
 - Measurement error
 - Battery charge status.
- ④ **Keyboard** - ergonomic, backlit.
- ⑤ **Memory card** (built-in) 2 MB, replaceable.
- ⑥ **Rechargeable battery** (built-in), replaceable
- ⑦ **Additional key** with ENTER function (Rear panel)

- ⑧ **A / B** - measuring channels for analog signals and charging sockets.
- ⑨ **Temperature** - interface for thermo couple type K
- ⑩ **Digital input/ analog output** for:
 - Trigger / RPM sensor
 - Data transfer via RS 232
 - Strobe control
- ⑪ **Communication** via Ethernet / USB

Getting started

Keyboard

The keys can be comfortably operated with the thumb of the right hand. In a dark environment the keyboard illumination automatically turns on.

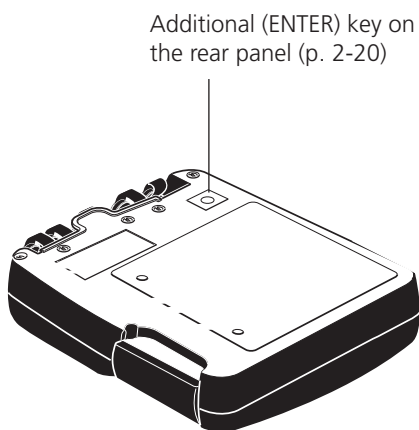

- ① **Plus (+) / Minus (-) key**
- Zoom for X axis
- Change tab
- ② **F key** for special functions such as tab, fast key, search
- ③ **Navigation keys and Enter key**
- ④ **MENU key** opens the menu with context-sensitive functions.
- ⑤ **On/ Off key** for switching on, switching off and restarting VIBXPRT.
- ⑥ **HELP key** opens context-sensitive help page in the active language.
- ⑦ **ESC key** is used to cancel an operation, to page back and to switch off VIBXPRT (only in the start screen).

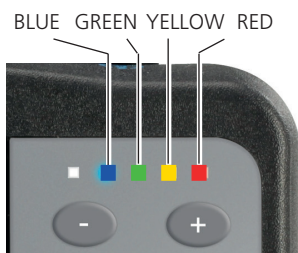

Status display per LED

Four colored LEDs indicate threshold violations, errors, and system status and show the battery status while charging in the device.

Flashing LEDs have the higher priority, i.e RED flashes with signal overload and alarm level exceeded.

Status and alarm indication

LED	RED ■	YELLOW ■	GREEN ■	BLUE ■
constant	Alarm	Warning	Prewarning	Meas. OK
flashing slow	Signal overload	Signal unstable	Display off / Meas. incomplete	Battery almost empty
flashing fast	Battery empty*	---	Trigger signal	---

* only when switching on

Battery status during charging

constant	Error	Battery charging	Battery full	---
-----------------	-------	------------------	--------------	-----

Notes on operation

To keep operation as simple and intuitive as possible, the graphical user interface guides the user step-by-step and is based on the 'Microsoft Windows' operating concept.

Switch on / off

To switch on the device, hold the On/Off key down for two seconds. VIBXPRT is ready for operation when the start screen appears. To switch off, press the On/Off key again for 2 seconds and confirm the resulting query to switch off with 'YES'.

Reset:

Press the On/Off key for approx. 5 seconds until the device switches off and restarts.

Switching on VIBXPRT



Navigation and editing

Select the screen elements with the cursor which can be moved by the navigation keys. The selected element is highlighted. To confirm the selection, press the 'Enter' key.

Some examples of navigation and editing are shown below:

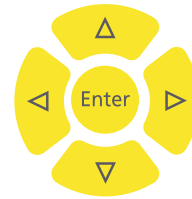

Fields

Black frame => 'Measurement channel' field is selected.

Grey frame => Selection confirmed. The settings can now be modified ('Channel A' or 'Channel B').



Tree view

'Plus symbol' => The folder contains further subfolders/files. To open a branch, press 'Enter' or the right navigation key.

To close a branch, press 'Enter' or the left navigation key.



File name	Type	Size	Date
Result files			
[-] FFT	Dir		01.03.2010 15:12:24
[-] Kennwerte	Dir		01.03.2010 15:12:24
[-] Modal	Dir		01.03.2010 15:12:33
[-] Nachlauf	Dir		01.03.2010 15:12:37
[-] Orbit	Dir		01.03.2010 15:12:37
[-] Phase	Dir		01.03.2010 15:12:16
[-] Rec FFT	Dir		01.03.2010 15:12:16

File name	Type	Size	Date
Result files			
[-] FFT	Dir		01.03.2010 15:12:24
[-] Kennwerte	Dir		01.03.2010 15:12:24
[-] Modal	Dir		01.03.2010 15:12:33
[-] Nachlauf	Dir		01.03.2010 15:12:37
[-] Orbit	Dir		01.03.2010 15:12:37
[-] Phase	Dir		01.03.2010 15:12:16
[-] Rec FFT	Dir		01.03.2010 15:12:16
[-] vrms 1K	ov all vel	1472	28.02.2010 19:16:53
[-] vrms 1Ktrend	ov all vel	1673	28.02.2010 19:16:53
[-] vrms 2K	1+1	2396	28.02.2010 19:16:53

Menu

The functions of the current program section are found in the 'Menu' which is displayed with the MENU key and hidden again with the ESC key.

MENU



An arrow next to a menu entry indicates a further submenu. To open it, press the right navigation key.

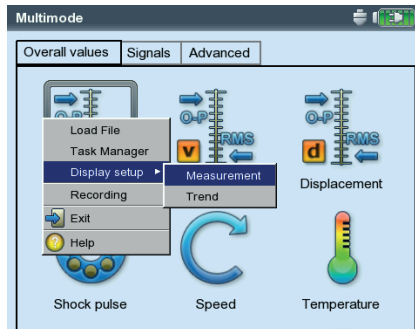

HELP

Tips and operating instructions are available for every screen in the program. Call up these help pages at any time by pressing the HELP key and close them by pressing the HELP key again.

Interfaces

The connections for the sensor and data cables are located on the front of the measurement device. The cable connectors and sockets are colored for easy identification.

To unplug the connector, push the connector sleeve backwards to release the lock. Only then should you remove the connector from the device. Never pull directly on the cable!

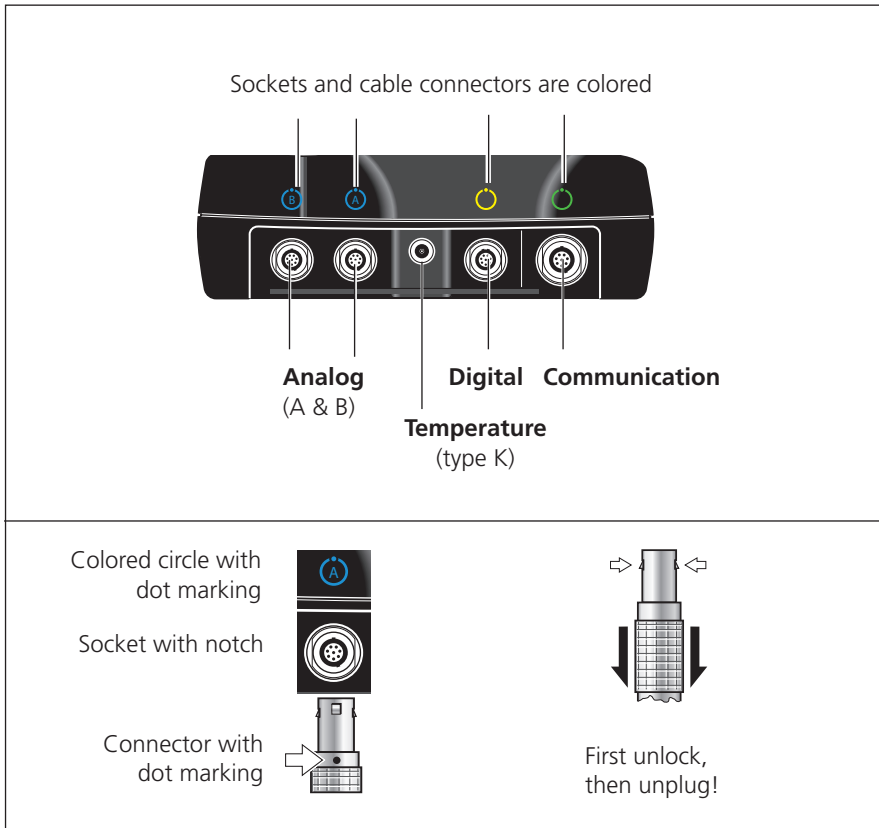

Top view

Analog

The blue channels marked with 'A' and 'B' are used as the:

- Input for analog signals
- Charging socket for the battery (A or B)

The sensor cable is connected to the channel (A or B) set in the measurement task.

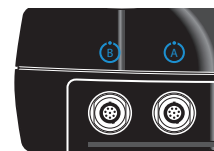

The analog measurement channels are not electrically insulated. For 2-channel measurement on two machines, check the potential equalization (VDE 0100) or use electrically insulated sensors.



Attention!



Digital

The yellow channel is used as the:

- Input for digital signals from a trigger or a RPM sensor
- Serial interface for data transmission (RS 232)
- Output for stroboscope control (TTL signal)



Attention!

The permissible range for trigger signals is:
-26V ... 0V (negative) or -5V ... +26V (positive).

Switching threshold positive:	max. 2.5V rising min. 0.6V falling
Switching threshold negative:	min. -8V rising max. -10V falling

The input signal must not exceed the switching threshold of the positive and negative range as otherwise incorrect measurements can occur.



Temperature

This interface is used for the connection of a thermo couple type K.



Communication

The green channel is used as the:

- Communication interface to the PC. The connection is established via a network (Ethernet) or directly via a USB cable.
- USB printer port.
- Connection interface for an USB pendrive.

The network is configured in the 'Device Setup' (see 'Ethernet' on page 2-28).

Power supply

VIBXPERT is supplied with energy by a Lithium-Ion rechargeable battery. With the power on the the battery icon on the display indicates the residual charge of the battery:

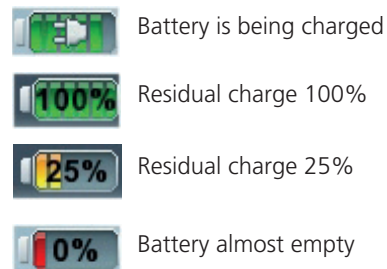
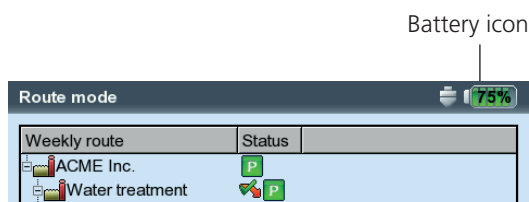

If the battery is almost empty, a message appears on the display and the blue LED flashes. The battery can be charged either in the device or in the external charging station (option, VIB 5.324) using the VIBXPERT charger (VIB 5.320 INT).

Follow the safety instructions enclosed with the charger.



Charging the battery in the device

Connect the charger to one of the two analog input channels (A / B). VIBXPERT can be operated during charging.

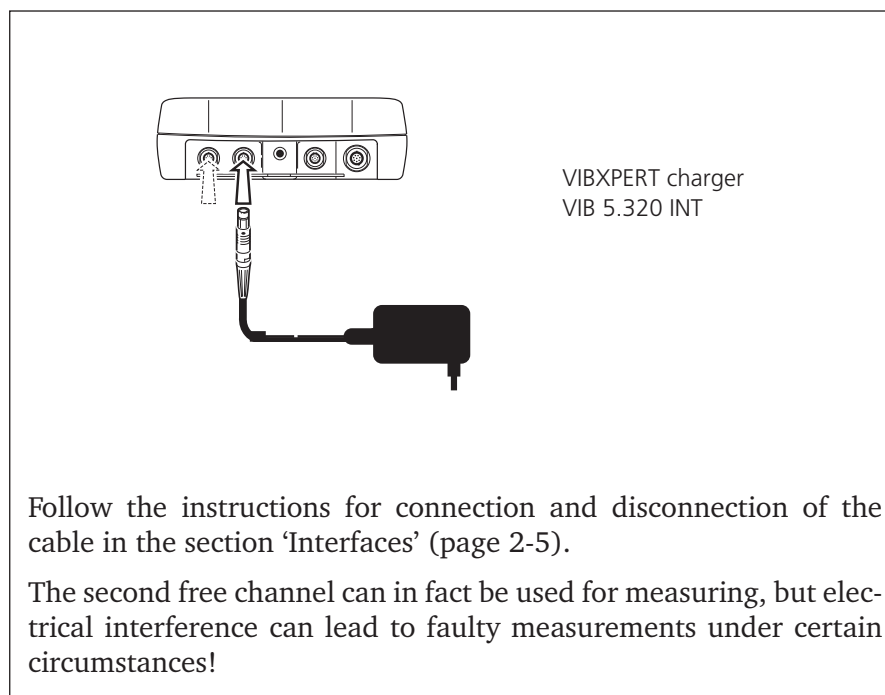

Getting started - Power supply

During extended periods of non-use and during storage, connect VIBXPERT regularly to the mains supply. This prevents the battery from becoming completely discharged, and the date and time settings are retained.

Charging in the external charging station

To remove the battery, loosen both screws on the back.



Attention!

The metal contacts on the battery, in the charging station and in the device should be protected against contamination and inadvertent contact!

Remove the battery

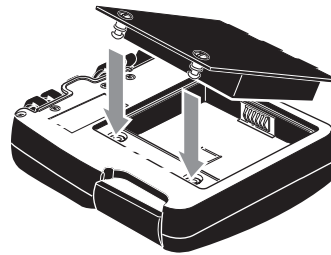

VIBXPERT charging station
VIB 5.324

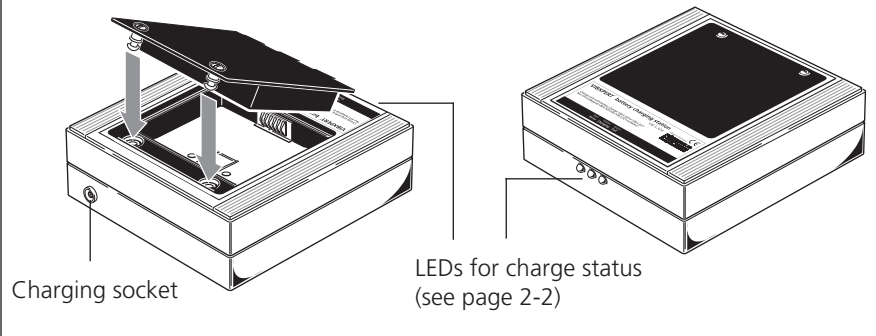

Carrying pouch - VIB 5.356

The stable and functional carrying pouch allows safe and convenient transport of the measurement device. A belt and a hand strap can be attached to the pouch:

Belt

Fasten the belt to the two diagonally opposite eyelets. Adjust the belt length so that the measurement device hangs comfortably from the shoulder to allow convenient operation.

Hand strap

The hand grip strap can be attached on the right or left side. To ensure a stable grip, put one hand in the strap.



Memory card

A CompactFlash (CF) card with 2 GB memory capacity is installed in the VIBXPERT as standard. If required, the standard card can be replaced by a card with greater memory capacity.



Attention!

Backup all data before replacing the card using the 'VIBXPERT utility' program (see page 5-5)!

When closing the cover, it must be additionally sealed with a silicone adhesive (NOVASIL S 11) to ensure the dust seal (IP 65).

Replacing the memory card

- Switch off VIBXPERT.
- Carefully remove the cover in the grip. Make sure that the clip of the cover is not damaged.
- Pull out the memory card by the adhesive strip.



Compartment for memory card open



Carefully pull out the memory card by the adhesive strip

- Installation:
Insert the new card in the guide rails of the card slot. Carefully press in the card up to the endstop. Make sure the card is correctly oriented! The top of the card should face the back of the device.

- Coat the groove along the edge of the card compartment cover with a small amount of silicone adhesive (NOVASIL S-11) and replace the cover. Remove any excess adhesive with a cloth.

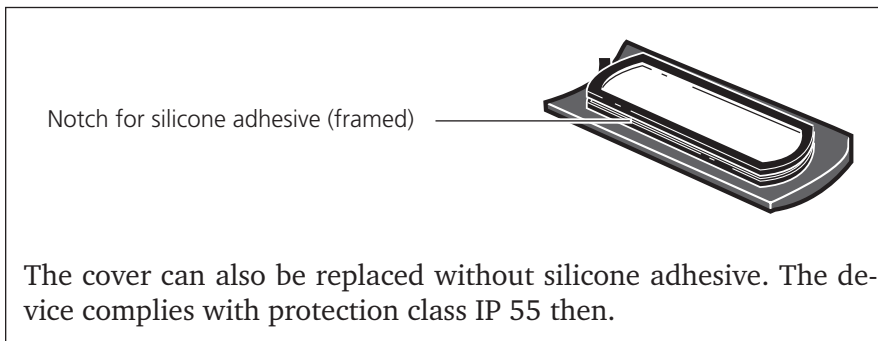

Note

When the device is switched on, the card is automatically tested. The following scenarios are possible:

Card formatted, which version?

- The card is new and has not yet been formatted in a VIBXPert: you are prompted to format the card.
- The card has already been used in another VIBXPert:
 - Card version < firmware version in the device: the files on the card are automatically updated.
 - Card version > firmware version in the device: you are prompted to reset all settings to the "factory settings" ('Reset', P. 2-23).
 - Card version = latest firmware version: no action.

Card faulty?

- The file system on the card is damaged. A warning appears along with the instruction to have the card repaired. If possible, make a backup copy of the measurement data (see 'Backup', page 5-8).

Start card formatting and repair in the 'Service' menu (P. 2-25).

How much free memory capacity is there?

The free memory capacity is checked regularly during operation. A message appears when the memory is almost full.

Basic settings - Device Setup

Before carrying out measurements with VIBXPRT, the basic settings in the 'Device Setup' should be checked and changed if necessary.



- Switch on VIBXPRT.
- Click on 'Device Setup' in the start screen. The 'Device Setup' screen appears.

Date & Time

The time and date are saved together with the measurement result.

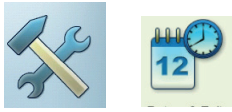

To change the settings:

- Click on 'Date & Time'.
- Click in the 'Time' window and select the numerals for the hours, minutes or seconds.
- To change the numeric value, press the navigation key up or down.
- When finished click on the 'Enter' key to leave the 'Time' window.
- Select the 'Time format':
HH:mm:ss = 24 h / hh:mm:ssAP = 12 h
- The date is set in the same way. Select the appropriate 'Date format'.

Other parameters

Time zone: Time shift to GMT (Greenwich Mean Time)
Daylight saving: Yes = + 1h

- To accept the changes, press MENU and click on 'OK'.

Left:
Basic settings in the Device Setup

Right:
Time and Date

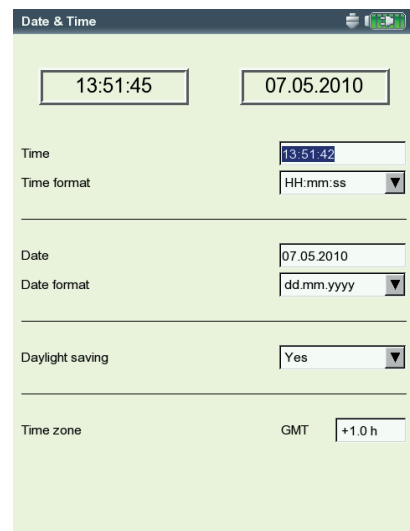

Display settings, switchoff and additional options

- Click on 'Display' in the 'Device Setup' screen.

BRIGHTNESS: Press the navigation key right or left until the desired brightness is achieved. To accept the setting, press 'Enter'.

SWITCH BACKLIGHT OFF / AUTO POWER OFF: The display/ the device automatically switches off if no action occurs within the turn-off time (illumination: 10s ... 1m / device: 6m ... 6h). To switch on the display, press any key. The automatic switch off is disabled in the measurement screen / results screen.

SHOW BATTERY CHARGE: Display the residual battery charge in percent.

SPECTRUM: SHOW LINES BELOW LOWER FREQUENCY (f_{\min}): In spectra with a lower limit frequency of $f_{\min.} > 0$ Hz, the lines between 0 Hz and $f_{\min.}$ are displayed in the diagram if this option is enabled.

HIDE CALIBRATION HINT: The message for overdue calibration is not shown.

- To accept the settings, press MENU and click on 'OK'.



Protective display film

To protect the display against damage, it is covered with a scratch-proof transparent film. The film is easy to remove.



Note

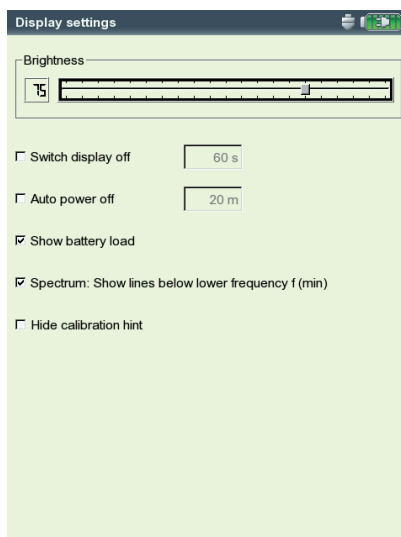

Display settings

Getting started - Basic settings



Transducers

The transducer menu (see below) contains all of the functions and pre settings for the transducer. Click on 'Transducers' to open the menu.

Available transducers in VIBXPRT

The measurement-relevant parameters for many transducers are stored in VIBXPRT. Consequently, when putting together a measurement task, it is only necessary to select the transducer required for the measurement.



The transducer list (see below) in the 'Available transducer' menu contains all the factory-configured and user-defined transducers. Under certain circumstances, this list can be very extensive.

Preselecting available transducers

As it is probable that not all the transducers stored in VIBXPRT will be used, the choice can be restricted to those transducers that are available to the user. When setting up the measurement tasks, VIBXPRT only offers the choice of the preselected transducers as standard:

- Click on each of the relevant transducers in the list so that these are marked with a cross.

Displaying the transducer application

To check in which measurement task(s) the individual transducers are used, proceed as follows:

- Mark the relevant transducer in the list.
- Press the MENU key.
- Click on 'Usage' (see below).

A list appears to show the measurement tasks that are measured with the transducer.

Left:
Transducer menu

Right:
Available transducers
are marked with

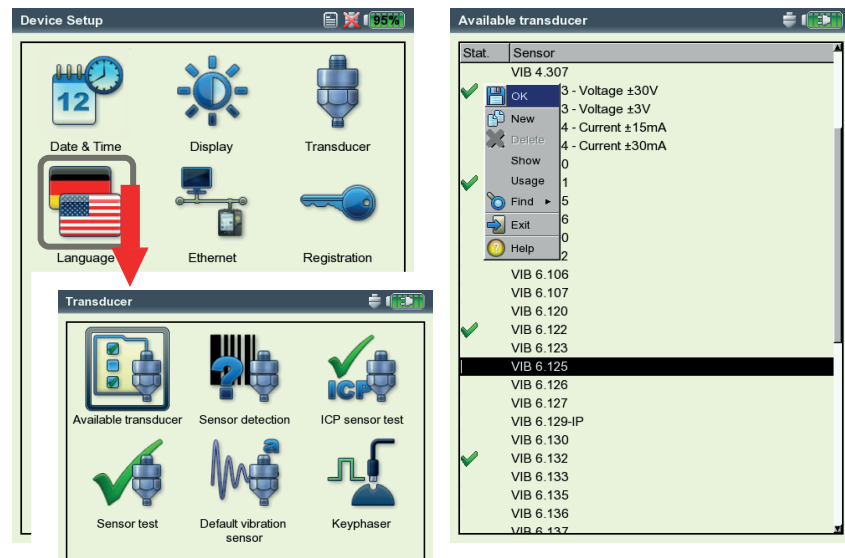

Filtering the transducer list

The transducer list can be filtered according to specific criteria:

- Press the MENU key.
- Click on 'Find'.
- Press the right navigation key wto open the associated submenu.

The following criteria can be selected here:

ALL: Display all transducers
 FACTORY: Display factory-configured transducers only
 USER: Display user-configured transducers only
 AVAILABLE: Display preselected transducers as 'available' only
 MEAS. QUANTITY: Display the transducers for a specific measurement quantity only; the measurement quantity is selected in the associated submenu (see below).

Setting up new transducers

To set up a new transducer, proceed as follows:

- In the transducer list press the MENU key.
- Click on 'New'. The Text Editor appears.
- Enter a name for the new transducer.
- Set up the transducer parameters (see page 3-12).
- Finally, press the MENU key and click on 'OK' to save the new transducer.

To accept the settings, press MENU and click on 'OK'.

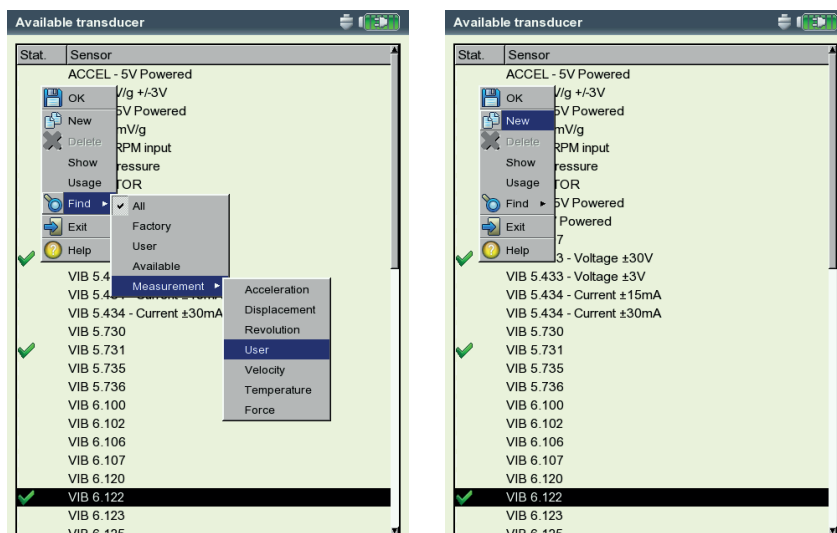

Left:

Filtering transducer list:

Display transducers for the 'user-defined' meas. quantity only

Right:

Creating a new transducer

Getting started - Basic settings



Note

Transducer detection and Hardware setting

In this menu, the transducer detection feature and the setting of the amplifier stages in VIBXPRT can be switched on and off.

The setting of the amplifier can only be activated when the transducer detection is switched off.

After the device is switched on, the amplifiers always settle prior to the first measurement.



Sensor test

Here you can manually check the measurement path to the sensor. For ICP sensors, use the 'ICP Sensor Test' menu; for all other sensors, use the 'Sensor Test' menu.

- Select the channel to which the sensor is connected (A, B).
- Click on START.
VIBXPRT then checks the measurement path and displays the result ('LineDrive', 'Open line', 'Short circuit', etc.).



Note

Default vibration sensor

A default sensor can be specified for all vibration measurements.

- Activate the checkbox and select the vibration sensor.

Default sensor is active, when

- channel A / B is marked red in the task selection screen
- the sensor icon at the top edge of the task selection screen is orange
- the sensor setup cannot be opened in the meas. task manager.

Use the default sensor for measuring or deactivate this option. Otherwise, incorrect measurements may be the result.

Left:
Default sensor for vibration measurement

Right:
Default vibration sensor is enabled

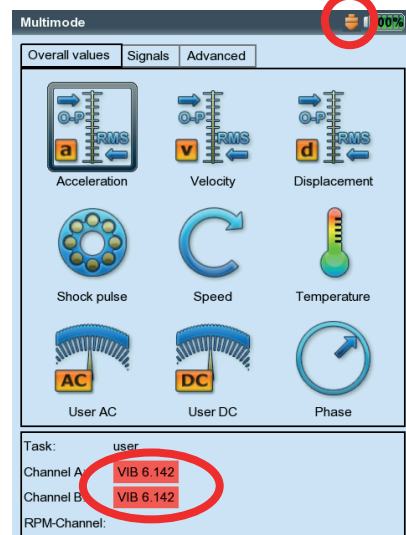
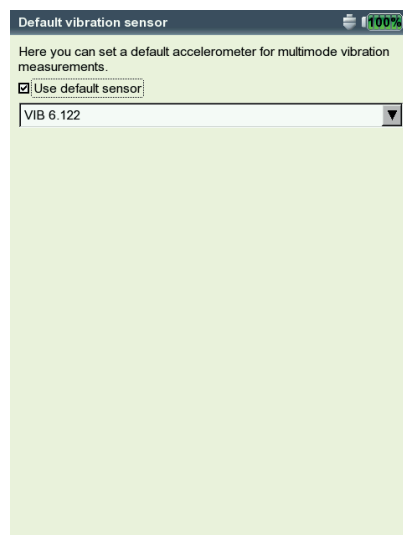

Keyphaser

Here you can extend the time limit set for rpm measurements and phase measurement to enable measurements on very low-speed machines (range: 10 ... 30 s, default: 10 s). In coast-down measurements the time limit is automatically set in relation to the stop speed.

The 'Active edge' option is used to define whether the edge of the incoming trigger mark or outgoing trigger mark on the shaft is to be used as the reference signal.



Definition of phase angle

Phase angle $\Delta\Phi$ is the angle between the reference edge of the trigger signal and the peak of the speed synchronous vibration. The 0° position is defined by the trigger sensor or the reference edge.

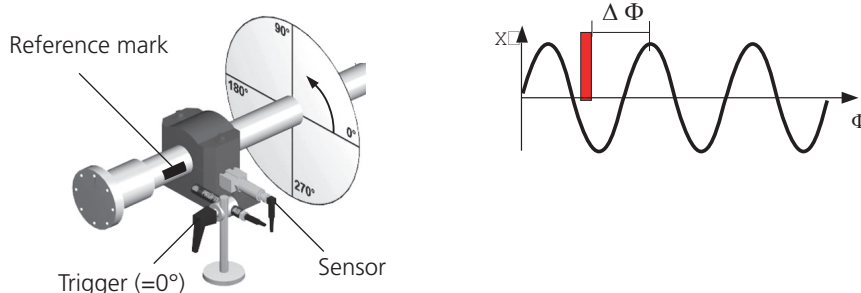

Definition of reference edge

Because of the finite width of the reference mark on the shaft, the reference signal itself has a certain width. If the wrong trigger edge is selected as a reference, the angular fault increases in size relative to the width of the mark and inversely to the shaft diameter.

It is therefore important to set the correct reference edge in the measuring device. In VIBXPERT and VIBSCANNER, either the incoming or outgoing edge can be selected. The edge setting must agree with the 0° position.

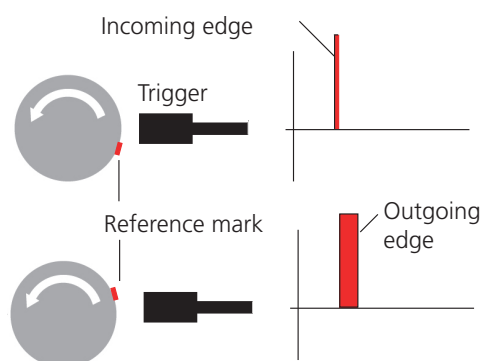

The terms 'incoming edge' and 'outgoing edge' are independent of whether the trigger issues a rising or falling signal for the incoming reference mark. This applies to all trigger types.

Getting started - Basic settings



Language

VIBXPERT includes 11 languages. The default setting is 'English'. To change the language setting, proceed as follows:

- Click on 'Language'.
- Click on 'YourLanguage' (e.g. Espanol, Francais,...).
- Press MENU and click on 'OK'.
- Confirm the resulting message to restart the application (see below).



Communication

Settings for network communication, see page 2-28.

Registration

For upgrading to VIBXPERT II you have to register the modules 'VIBXPERT - 1 channel', 'VIBXPERT - 2 channels' and 'Balancing'. The corresponding password can be found on the associated registration certificate:



- Click on 'Registration'.
- Click on the module to be registered and enter the password in the text editor.

Left:
Dialog language
is changed to 'Deutsch' (German)

Right:
Registration menu

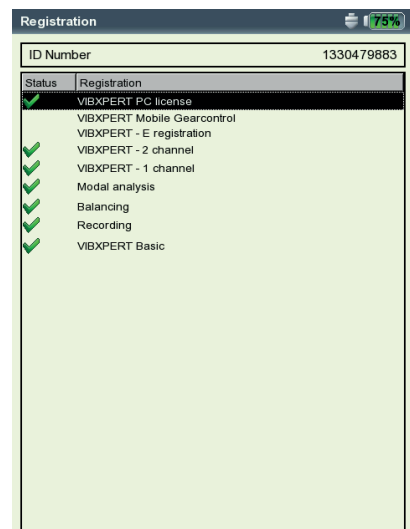

Units

The units - where appropriate - are set to SI units in the factory. To change the unit for the respective measurement quantities, proceed as follows:

- Click on 'Units'.
- Select the units for the measurement quantities.

The accuracy in decimal places appears in the lower area of the window for the current unit as well as the conversion factor for the associated SI unit. It is not yet possible to define, delete or edit units. The number of decimal places can not be changed.

To accept the settings, press MENU and click on 'OK'.



Unit settings	
Acceleration	m/s ²
Velocity	mm/s
Displacement	µm
Temperature	°C
Frequency	Hz
Order	orders
Revolution	rpm
Time	s
Length / Radius	mm
Line speed	m/min
Angle	°
Mass	g
Unbalance	g*mm
Rotor mass	kg
Acceleration	
Precision	3
1 m/s ² =	1.0000 m/s ²

Units menu

Key controls

Additional functions are activated for some keys in VIBXPERT as standard that are intended to ease working on-site on the machine or to increase data security.



- Click on 'Key controls'.
The following options can be activated or deactivated in the next screen:

Additional key on the rear panel

VIBXPERT has an additional input key on the rear panel which can be operated with the index finger of the left hand (see below). This key can be used as an additional ENTER key or for starting a measurement.

This key is particularly useful if it is not possible to press the 'Enter' key - e.g. if a hand-held probe must be held on the machine with the right hand.

'Save?' prompt after ESC

The 'Save?' prompt appears if you press the ESC key without having saved the changes/measurement results in the current screen beforehand. This query always appears for run-up and coast-down measurements, even if this option is disabled.

Prompt for repeat measurement

A repeat measurement is normally started by pressing the 'Enter' key in the measurement screen. A corresponding prompt prevents inadvertent triggering of a repeat measurement.

To accept the changes, press MENU and click on 'OK'.

Special keyboard functions

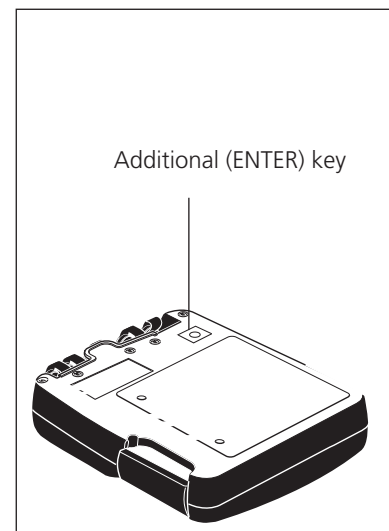
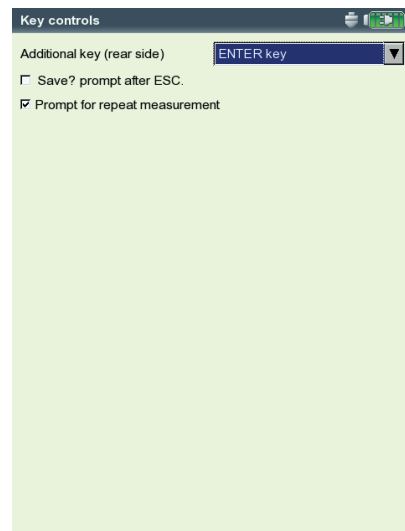

Printer

With VIBXPRT, you can print out measurement results, reports and PDF file directly on a USB-printer.

- Click on the 'Printer settings' icon to open the Printer menu.



Setting up a printer

To set up a new printer, proceed as follows:

- Click on the 'Printer settings' icon to open the 'Printer settings' menu (see below).
- Select the top menu, press the MENU key and click on 'New' (see below).
- Select your printer type.
- Enter a name in the text editor.
- Then set the print parameters:
Resolution, paper format and - depending on the printer type - the color model and paper source.
- Check the print function by printing a test page:
 - Connect VIBXPRT to the printer (see the next page).
 - Press the MENU key and click on 'Test page'.

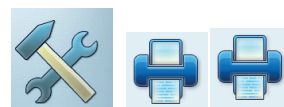

The test page is printed as soon as the print job has been processed by VIBXPRT. If you select 'PDF' as the printer, you can print the PDF file directly from the measurement device (see page 5-4) or transfer the PDF file to a PC using the 'VIBXPRT utility' tool (see p. 5-8).

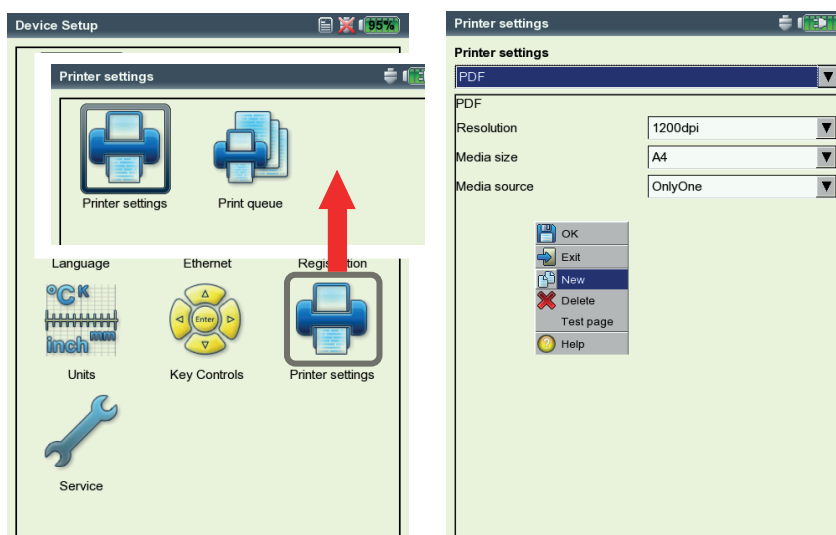

Left:
Printer menu

Right:
Printer settings

**Deleting a print job**

- Click on 'Print queue' in the 'Printer settings' menu.
- Select the print job in the list.
- Press the MENU key and click on 'Delete job'.

If a print job is being processed, a print icon appears at the top edge of the screen.

Print job is being processed

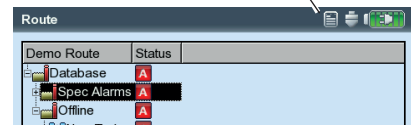

Service menu

- Click on 'Service' to open the Service main menu (see below).

A series of functions are available for service, maintenance and training purposes. For clarity, the settings are grouped into submenus:

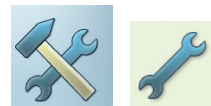

Device Info

This menu contains device information for service and repair as well as the date of the next offset compensation and calibration (for more details, see also p. 5-10).

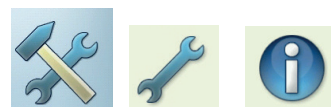

Offset Compensation

Various factors, e.g. aging or temperature, can cause an offset in the analog electronics. This option makes it possible to maintain the measurement accuracy of the instrument by regularly (approximately every 2 months) compensating the offset.

- Click on 'Offset Compensation'.
- Click on 'Start' in the next screen. The process takes about 3 minutes.

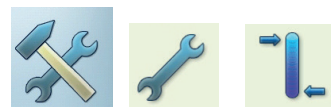

Factory Defaults

This menu can be used to reset various settings in the instrument to the values set up in the factory. In addition, data that are no longer required in the instrument, e.g. language files, can be deleted.

- Click on 'Reset'.

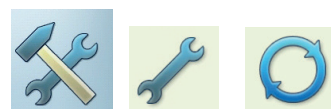

!! RISK of DATA LOSS !!
 Pay particular attention to which settings are reset or which data are deleted. This action cannot be undone!

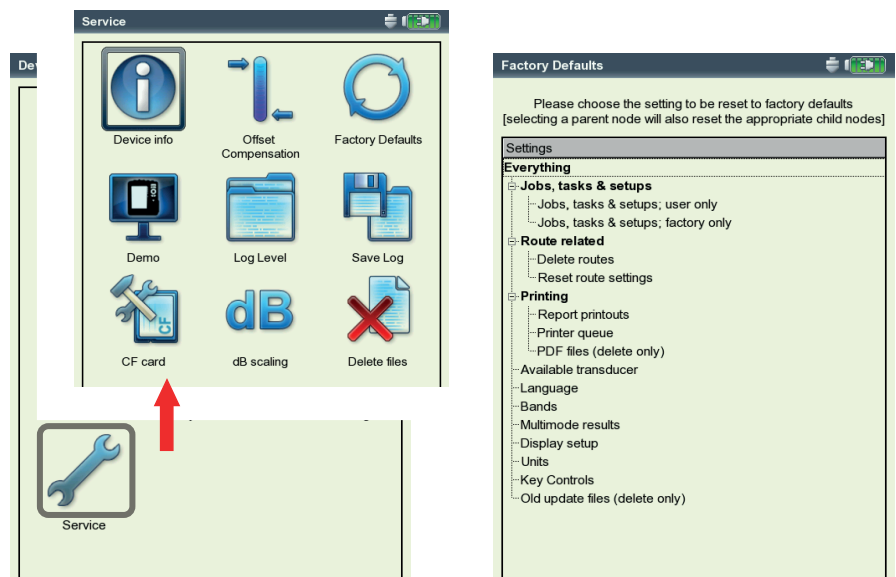

Left:
Service main menu
 Right:
Factory defaults

- Click on the respective tree entry and confirm the resulting prompt with 'OK'.
- For reasons of security, the word 'OK' must be entered a second time in the text editor before the action can be carried out.

Demo

For training or demonstration purposes, the VIBXPRT screen display can be shown on a PC monitor with the aid of the VIBXPRT demo program. VIBXPRT must be switched to 'Demo' mode for this.



- Click on the 'Demo' icon. The following options can be selected:
 - ETHERNET: VIBXPRT can only be operated using the keys on the device. The unit is connected to the PC via a patch/network connection (see p. 2-26f).
 - OFF: Stop 'Demo' mode.

LogLevel

To simplify troubleshooting, the operating steps can be logged in the device and written to a log file. This menu is used to set how much data is to be written to the log file ('LogLevel').

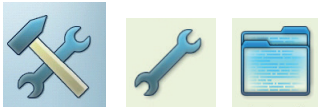

- Click on the 'LogLevel' icon. Select one of the following options:
 - NONE: No logging
 - DEFAULT: Only the most important operating steps are logged.
 - RUNTIME/ ... / SPECIAL USE: The amount of logged information is increased from step to step.



The higher the LogLevel is set, the higher the demands on the system resources. Increasing the LogLevel should only be carried in consultation with PRÜFTECHNIK Condition Monitoring.

When processing Coast Down analyses set the LogLevel to 'None'. After a reboot the LogLevel is set to 'default', if the LogLevel was set before to levels higher than 'default'.

Left:
Demo mode settings

Right:
LogLevel settings

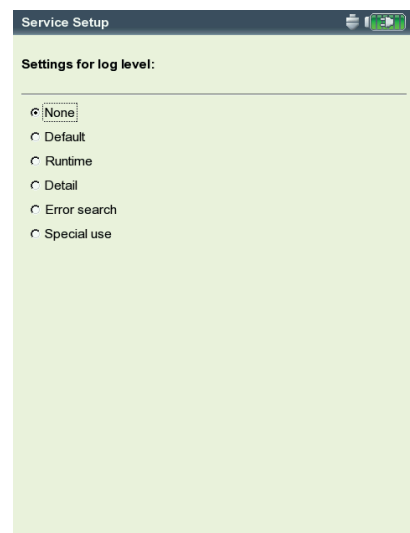
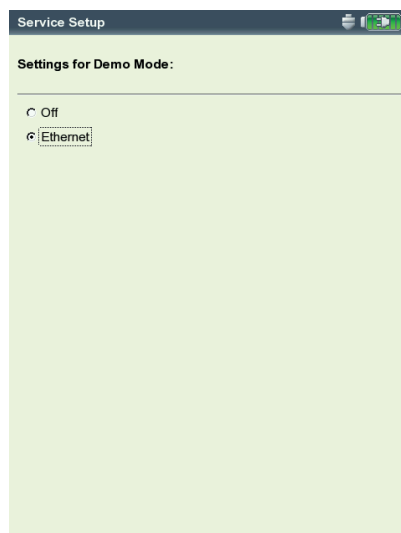

To backup the log file on the memory card in the VIBXPERT, click on the 'Backup Log' icon and confirm the prompt with 'Yes'. The log file can be transferred to the PC using the 'VIBXPERT update tool'.

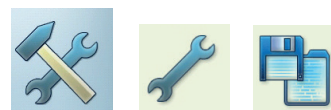

Memory card (CF)

In this menu, you can format, check and repair the memory card.

FORMATTING: You should only format a card if it is new and has not yet been used in VIBXPERT. This process deletes all data stored on the card!

To format it, click on 'Start' in the top field, confirm the query that is displayed and enter the word 'OK' into the text editor.

CHECKING: The degree of fragmentation is checked automatically at specific intervals. Here you can start the check function manually by clicking on the 'Start' button.

REPAIRING: If the file system on the memory card is faulty, an error message appears. If possible, save the measurement data on the PC before starting the repair function.

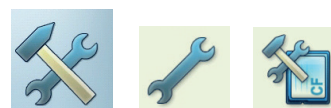

Standardization factor for dB scaling

The amplitude of a spectrum is converted to decibels (dB) with the following formula:

$$A_{\log} = 20 \cdot \log(A_{\text{lin}}/N), \text{ where } \begin{array}{l} A_{\log}: \text{ amplitude in dB} \\ A_{\text{lin}}: \text{ amplitude in linear unit} \\ N: \text{ standardization factor} \end{array}$$

In this menu, you can set the standardization factor (default = 1). The scaling that is used for a spectrum (linear or in dB) is defined in the Display Setup (see Chapter 4).

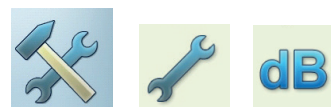

The dB scaling is not available for time signals and overall values.



Note

Deleting files

Files that are no longer needed can be deleted in this menu. Select the data type and press the F key to open the file selection list.

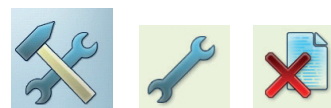

F

Data transfer

The following data is transferred between VIBXPRT and the PC:

- Measurement tasks to VIBXPRT (route)
- Software (update)
- Printer drivers to VIBXPRT
- Data backup to the PC
- Data restore to VIBXPRT
- PDF and screenshots to the PC

For transferring the data use the 'VIBXPRT utility' tool found on the PRÜFTECHNIK CD. This program must be installed locally on the PC. Measurement results can be exported in CSV format and output as an Excel report. PDF files can be saved to a USB pen drive, so they can be opened and printed from a PC.

Exchanging data between the measuring device and a PC requires either a direct connection or a network connection.

Direct connection to PC

- SERIAL CONNECTION: Connect the PC cable VIB 5.430-2 to the digital port (yellow) and serial port of the computer.
- USB CONNECTION: Connect the USB cable VIB 5.330SUSB to the communication port (green) and USB port of the computer.

Serial and USB

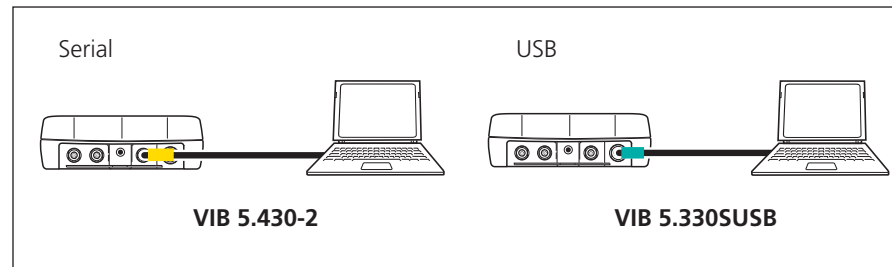

- PATCH CONNECTION: Connect the Ethernet cable VIB 5.331 to the communication port (green) and network card of the computer.
- PATCH CONNECTION VIA HUB: Connect the Ethernet cable VIB 5.331 to the communication port (green). Connect a standard patch cable to the network card of the computer. Connect both cables to a hub.

Patch (RJ 45)

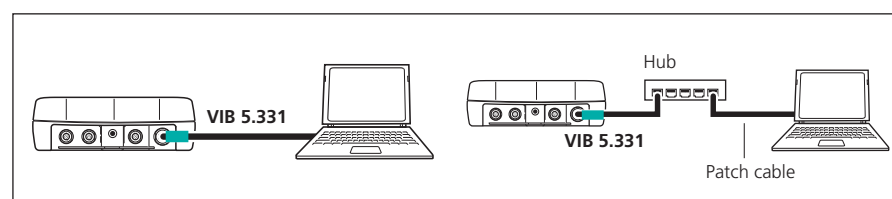

Network connection

Data transfer via an Ethernet network requires the following components and information:

- Network connection
- Ethernet cable for VIBXPERT (VIB 5.331).
- PC with network interface card connected to the network/hub
- IP address and subnet mask of the PC in the network
- UPD port 55737 must be enabled

NETWORK CONNECTION (LAN): Connect the Ethernet cable VIB 5.331 to the communication port (green) and network socket.

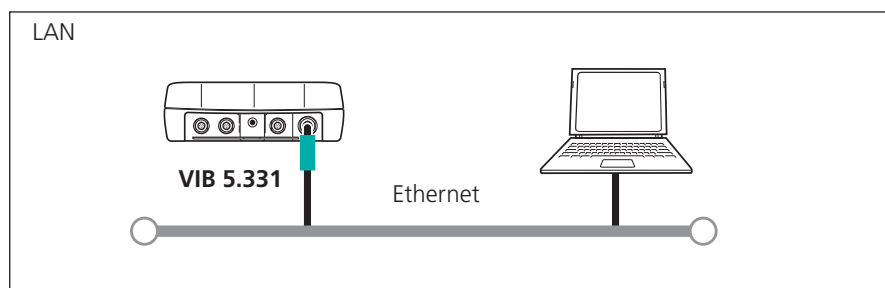

Network (LAN)

USB pen drive

To save PDF files to a USB pen drive, you need the following accessories:

- Cable for USB pen drives (VIB 5.330AMEM)
- USB pen drive for VIBXPERT II (VIB 5.350-USB)

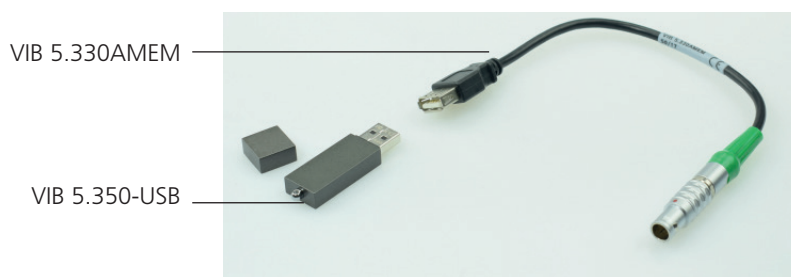

In the file manager the USB flash drive is shown as an additional directory next to 'Results' and 'PDF'. You can move saved PDF files to the USB pen drive with the menu options 'Cut' and 'Insert'.

Setting up the network communication

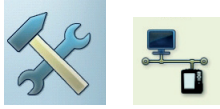

- Connect VIBXPERT to the network (see previous page).
- Switch on VIBXPERT.
- Click on 'Device Setup' in the start screen, and then on 'Ethernet':
- Enter a valid IP address for VIBXPERT:
Take the first three numbers of your PC's IP address and change the last number only (see also the following instructions). Make sure that the IP address for VIBXPERT is not already allocated in the network. Contact your system administrator if you work in a company network.
- In the 'Subnetmask' field, enter the address of the subnetwork where the PC is located.
- If necessary, enter the address of the gateway in the 'Standardgateway' field. If no gateway is used, set the field to '0.0.0.0'.
- To accept the settings, press MENU and click on 'OK'.

Left:
Open menu for
network communication

Right:
TCP/IP settings for
network communication

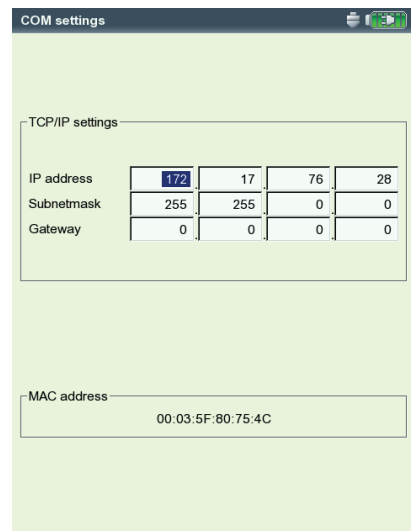

IP address of the local PC in the network

If the IP address and the subnet mask of the PC are not known, ask your network administrator or find it yourself on the PC:

- Open the Windows command line editor ("cmd").
- Enter "ipconfig -all" .

```

C:\WINNT\System32\cmd.exe
C:\>ipconfig -all
Windows 2000 IP-Konfiguration

Hostname . . . . . : pc_achter
Primäres DNS-Suffix . . . . . :
Knotentyp . . . . . : Hybridadapter
IP-Routing aktiviert. . . . . : Nein
WINS-Proxy aktiviert. . . . . : Nein
DNS-Suffixsuchliste . . . . . : pruftechnik.com

Ethernetadapter "LAN-Verbindung":

Verbindungsspezifisches DNS-Suffix: pruftechnik.com
Beschreibung. . . . . : 3Com EtherLink XL 10/100 PCI f³rool
Istöndige PC-Verwaltung-NIC (3C905C-TX) . . . . . :
Physikalische Adresse . . . . . : 00-04-76-0C-4D-7B
DHCP-aktiviert. . . . . : Ja
Autokonfiguration aktiviert . . . . . :
IP-Adresse . . . . . : 172.17.5.59
Subnetzmaske . . . . . : 255.255.0.0
Standardgateway . . . . . :
DHCP-Server . . . . . : 172.17.1.61
DNS-Server . . . . . : 192.168.10.1
Primärer WINS-Server . . . . . : 172.17.1.40
Sekundärer WINS-Server . . . . . : 172.17.1.3
Lease erhalten. . . . . : Dienstag, 2. Dezember 2003 10:37:32
Lease läuft ab. . . . . : Dienstag, 2. Dezember 2003 11:37:32

C:\>

```

Command line - cmd

Example: The screen displays the IP address and the subnet mask of a PC in a network:

IP address: 172.17.5.59
Subnet mask: 255.255.0.0

Entering a fix IP address for the local PC

You must assign a fixed IP address to the computer if you connect the computer directly to the measurement device with a patch cable. Please refer to the operating systems documentation for further assistance.

Update

Technical developments and improvements to the firmware are transferred to the device via an update. The current version can be obtained from your PRÜFTECHNIK sales partner.

Preparation:

- Backup the measurement data into the OMNITREND database.
- Connect the device to the mains supply. Otherwise, the update procedure will not start.
- Install the 'VIBXPERT update tool' on the PC under C:\Programs\Pruftechnik\vibxpert\VxpUpdateTool.

Update procedure:

- Connect VIBXPERT to the network / or to the PC (USB).
- Switch on VIBXPERT.
- Start the 'VIBXPERT update tool'* on the PC and click on <Next> to call up 'Step 2'.
- Set the 'Communication type' to 'Ethernet' (or 'USB').
- Only with network connection: Enter the IP address of the VIBXPERT and ensure that UPD port 55737 is enabled.
- Click on <Next>:

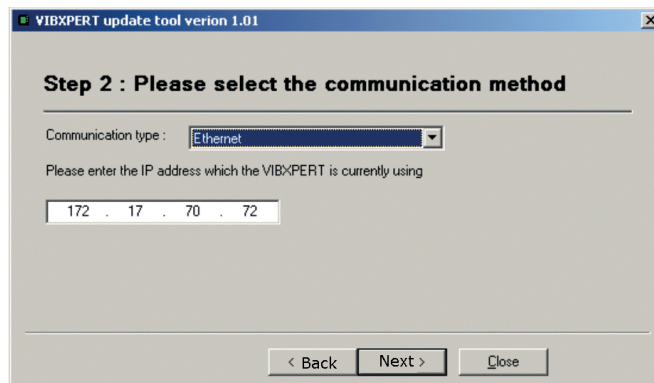

- In the next step ('3') select the update file on the PC.
- Click on <Next>:

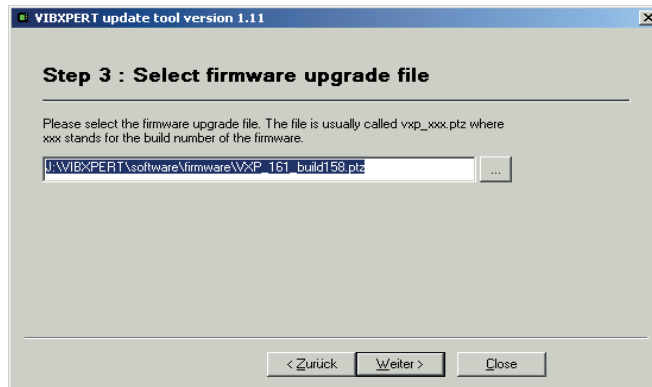

- In the next step ('4') click on <Download> to start the data transfer to VIBXPert.

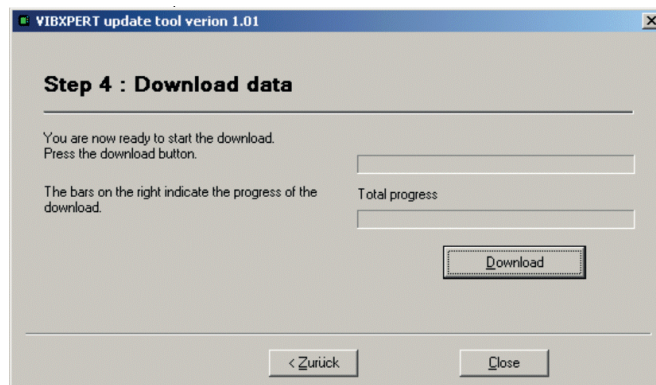

- After the data transfer has finished, click on <Close> to close the program.
- The device switches itself on and off repeatedly until the update is completed. This process generally takes a few minutes. Wait for the VIBXPert start screen to appear.

The version number appears in the lower right corner of the start screen:

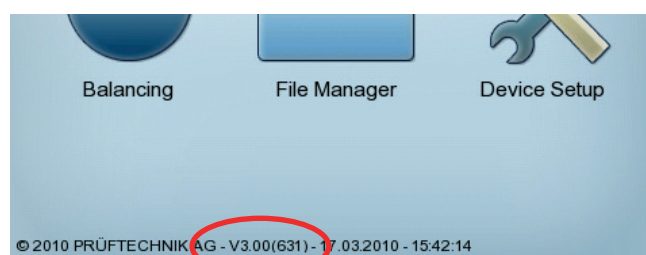

Chapter 3: Vibration analysis

With a vibration analysis you can determine whether an imbalance may be the cause for increased machine vibrations. Resonance tests and phase measurements assist you in the diagnosis and help you to determine the optimum operating conditions for the rotor.

For this purpose VIBXPERT provides a comprehensive collection of vibration measurement tasks in the 'Multimode' operating mode.

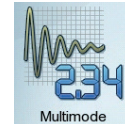

Selecting the measurement task

- Click on 'Multimode' in the start screen.
The measurement tasks appear in the selection screen (see below):

Each icon is associated with a measurement task. The icon indicates the type of measurement (characteristic overall value, spectrum) and the measured quantity (eg vibration velocity). All other settings are grouped in setups and can be changed if necessary. The measurement task for the selected icon is displayed below the icon field.



Changing the current task:

- Highlight the corresponding icon, ...
- ... press the F key and select the required measurement task from the list (see below left).



OR

- ... press the MENU key, and click on 'Task manager' to set up a new measurement task (see page 3-6).



The measurement tasks are grouped into three tab sheets: Analysis, Signals, Advanced. The current tab sheet is highlighted with a black frame. To change the tab sheet, press the '+/-' key or highlight the tab sheet with the navigation keys.



Default vibration sensor enabled

Multimode selection screen for overall value measurements

Tab

Measurement quantity (icon)

Info field

Measurement task

Sensor type: VIB 6.142 (here: default sensor)

What is a measurement task?

To carry out a measurement, VIBXPERT requires information on the type of measurement*, the sensor being used and, if necessary, data for the evaluation of the result. Information as to whether the RPM must be recorded with each measurement is also required. This data set is designated as a 'measurement task' and forms the basis for each measurement with VIBXPERT.

To simplify the preparation of a 'multimode' measurement and to save the user from having to enter the required data, VIBXPERT already contains a comprehensive collection of predefined knowledge-based measurement tasks. The user is only allowed to change the transducer and to alter the measurement channel in these measurement tasks. If extensive changes to the measurement parameters are required, it is better to create a new measurement task.

The following overview shows the structure of a measurement task in VIBXPERT:

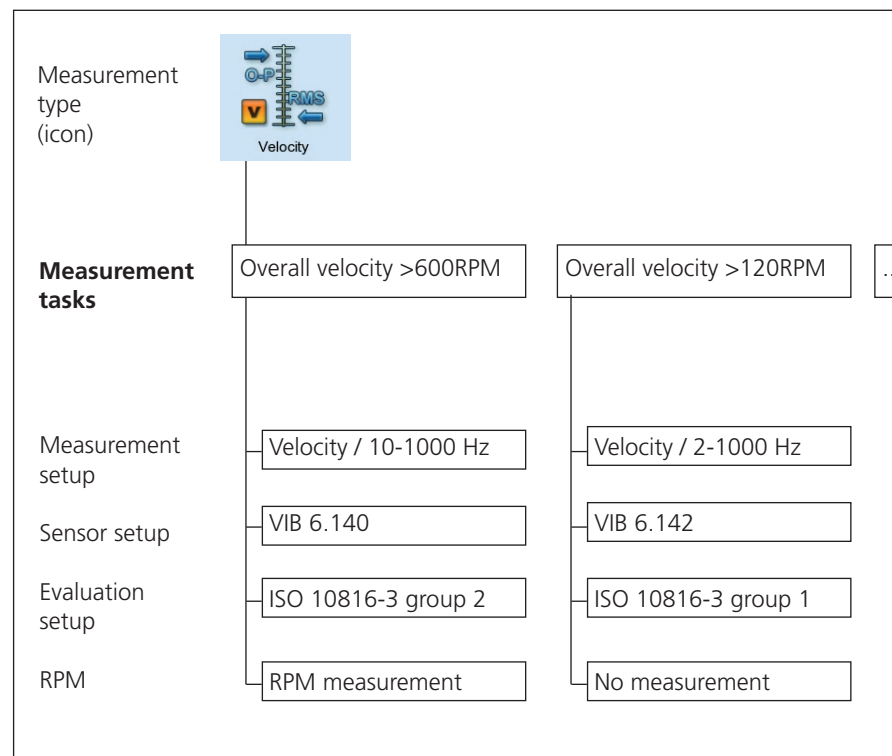

Measurement, Analysis, Diagnosis

Preparation

Before beginning a measurement, ensure that ...

- ... the battery is fully charged
- ... the device settings are set properly (date, units, ..)
- ... the required tasks are created and stored in VIBXPRT.
- ... the required sensors and cables are laid out and in good condition; the RPM sensor requires a support to perform RPM measurements!
- ... permanently mounted measurement locations are in good condition. If necessary, clean them and repair any damage.
- ... recesses for hand-held probes are prepared.

Starting a measurement:

- Highlight the measurement icon in the selection screen.
- Connect the sensor.
Sensor and measurement channel are displayed in the info field.

Standard sensor is active when the sensor icon at the top right is orange and the sensor type in the info field is marked red! The sensor setup is overwritten with the standard sensor.



- Press 'Enter' to start the measurement.

Continuous measurement (live mode)

In 'live mode', the signal is measured and displayed continuously. This lets you check the signal and the stability of the measurement. It is not available for time-limited measurements, such as the coastdown and impact test.

Initiate live mode automatically

Open the Display Setup and enable the 'Continuous measurement' option (see p. 3-27). The actual data collection begins when you press 'Enter' again.

Progress bar Live mode enabled

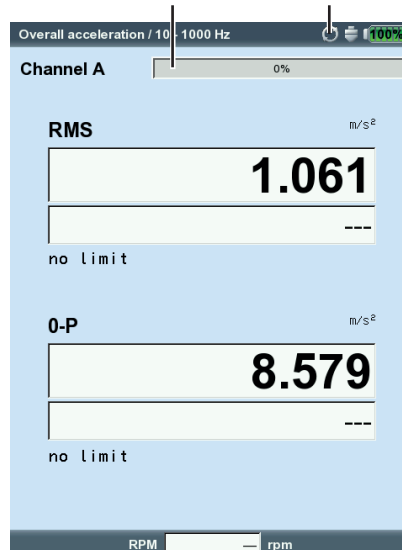
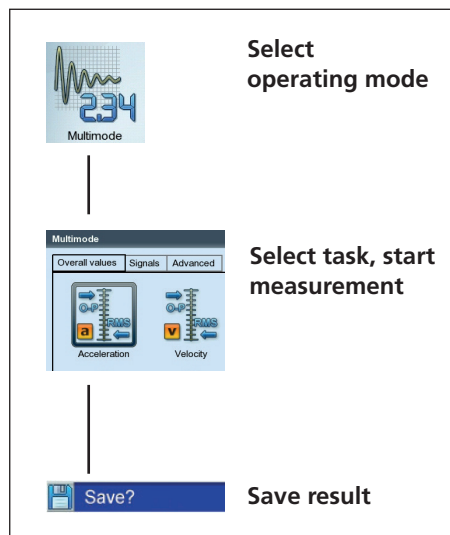

Left:
Typical sequence of a multi-mode measurement

Right:
Measurement screen, overall values

Initiate live mode manually

Keep the 'Enter' key pressed when the measurement starts. The actual data collection begins when you release the 'Enter' key.



Note

If the live mode starts automatically, the 'Live' symbol appears in the title bar and the progress bar remains at 0% (see below).

Before every measurement, VIBXPRT checks that the sensor and cables are correctly connected if sensor detection is activated in the device setup (p. 2-16). In measurements with trigger (phase, orbit,...) the trigger signal is monitored. If the trigger signal fails during measurement, the green LED flashes after the measurement. The measurement must then be repeated.

Save result

After completing a measurement, the blue LED lights if no measurement failures have occurred and no limit value has been exceeded (P 2-2).

- Press the MENU key and click on 'Save' (see below).
- Enter a file name (File manager and Text editor see P. 5-2ff).

Save result

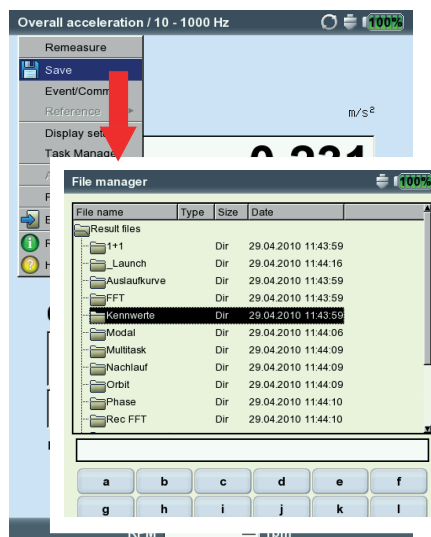

Options before, during and after a measurement

Aborting a measurement

- Press the ESC key during the measurement.

ESC

Repeating a measurement

- In the results screen, press 'Enter', or ...
- Press the MENU key in the results screen and click on 'Remeasure'.

Enter

Changing the measurement channel

Multimode:

- Highlight the measurement type in the selection screen.
- Press the MENU key, and click on 'Task manager'.
- Click on the 'Measurement Channel' field to activate it (see below) and then select the measurement channel (A, B , A/B).
- To save the change, press the MENU key and click on 'OK'.

MENU

Changing the sensor

- Highlight the measurement type in the selection screen.
- Press the MENU key, and click on 'Task manager'. The Task Manager appears and can be used to set up the new sensor.
- In the 'Sensor Setup' field click in the pull-down menu and select the required sensor.
- To save the change, press the MENU key and click on 'OK'.

Open the 'Task Manager '

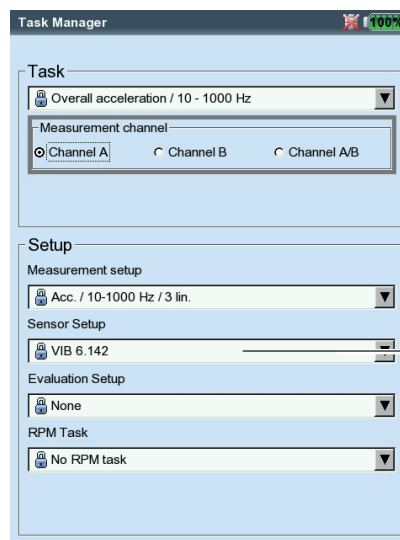
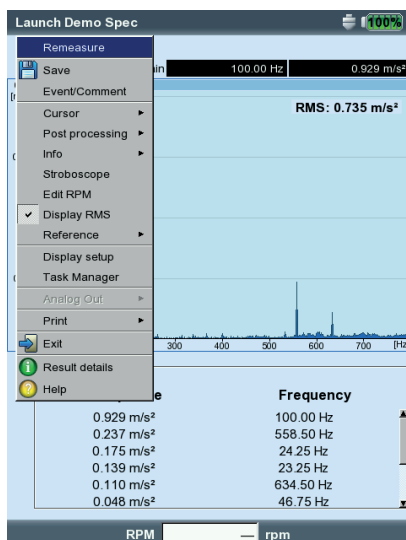

Left:
Repeat measurement

Right:
Change meas. channel / sensor
in the task manager

Setting up a new measurement task



Note

User-defined measurement tasks cannot be created for the measurement types 'amplitude spectrum' and 'envelope spectrum'.

To configure a new measurement task, proceed as follows:

- Highlight the measurement type in the selection screen.
- Press the MENU key and click on 'Task Manager'. The Task Manager appears and can be used to set up the new measurement task (see P. 3-2).
- Click on the 'Measurement task' pull-down menu.
- Press the MENU key and click on 'New'. The text editor appears.
- Enter a name for the new measurement task.
- Change the measurement channel if necessary.
- Select the setups for measurement, sensor, evaluation or RPM in the 'Setup' field of the pull-down menu. If the matching entry cannot be found, a new setup must be created (see next section).
- Then press the MENU key and click on 'OK'.

Creating a new setup



Note

A new measurement setup, evaluation setup or rpm setup can only be created for user-defined measurement tasks.
A new sensor setup can also be created for preset measurement tasks.

How to create a new setup:

- Open the 'Task Manager'.
- Select a user-defined measurement task.
- Click on the pull-down menu where the new setup should be created.
- Press the MENU key and click on 'New'.

Open the Task Manager

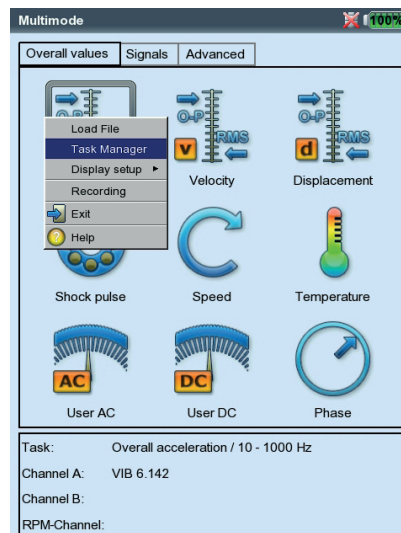

- Enter a name in the text editor.
- Then set up the Setup parameters:
 - Press the MENU key.
 - Click on 'Edit'.
 - Change the parameters as required:
see sections A to D on the following pages.
- To save, press the MENU key and click on 'OK'.

How to review the setup parameters:

- Open the 'Task Manager'
- Select the setup in the respective pull-down menu.
- Press the MENU key, and click on 'Show*' or 'Edit*'.

*'Show' appears for factory-defined setups whose parameters cannot be edited.

In which measurement task was the setup already used?

- Open the 'Measurement Task Manager'.
- Select the required setup.
- Press the MENU key and click on 'Show' or 'Edit'.
- Press the MENU key and click on 'Usage'.

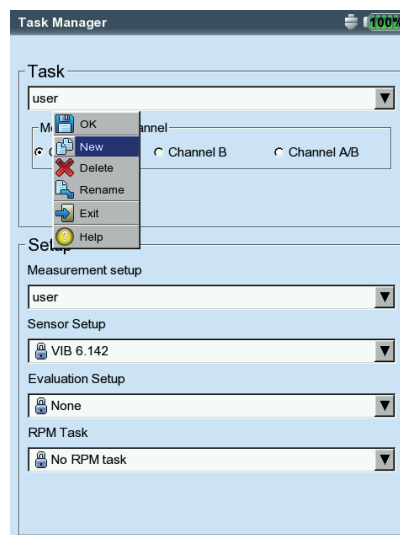

Create a new setup

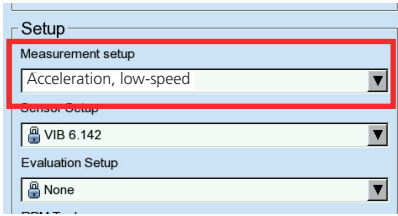

A. Measurement setup parameters

MEASUREMENT QUANTITY

The measurement quantity is fix and is defined via the measurement icon. Exception: The measurement quantity can be changed for the 'Impact test', 'Phase' and 'Coastdown' measurement tasks.

SAMPLE FREQUENCY (TIME WAVEFORM)

The sample frequency defines the maximum upper frequency and influences the maximum measurement time.

MEASUREMENT TIME (OVERALLS, TIME WAVEFORM)

Duration of an individual measurement; in overall measurements the measurement time depends on the lower frequency. In time waveform measurements the measurement time defines the length of the time window and depends on the sample frequency. The maximum measurement time is 640 s.

LOWER/UPPER FREQUENCY (F_{\min} / F_{\max}):

Overalls: Frequency range of the vibration measurement. The DC component of the signal can be recorded for the 'Vibration displacement' and 'User-defined' measurement tasks ($F_{\min} = \text{DC}$).

Amplitude spectrum: Frequency range is fix.

Envelope spectrum: F_{\max} is fix and set to 800 Hz.

* parameters are fix

AVERAGE TYPE / NO. OF MEASUREMENTS (OVERALLS, SPECTRUM*, TIME WAVEFORM)

WITHOUT: During the measurement each measurement is displayed. The last measurement is evaluated.

LINEAR: Single measurements are added and divided by the number of averages. This averaging type emphasizes recurring stationary sections in the signal. Default setting for spectrum.

EXPONENTIAL: Individual measurements are exponentially averaged (the last measurement is given the highest weighting).

PEAK HOLD: Highest measurement value is displayed. This type of averaging emphasizes peaks that occur stochastically.

TIME-SYNCHRONOUS: The individual measurements are averaged on a RPM synchronous basis. Reference transducer required.

Measurement setup for

- Overall vibration (left)
- Time waveform (right)

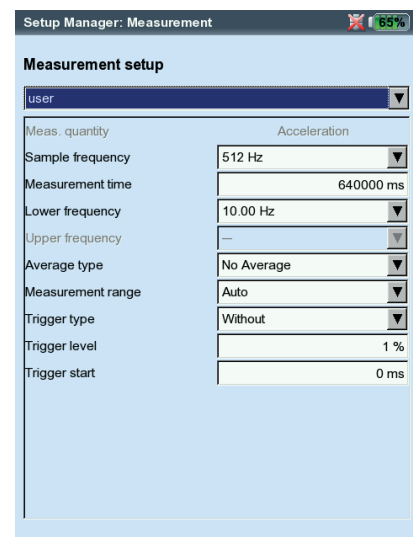
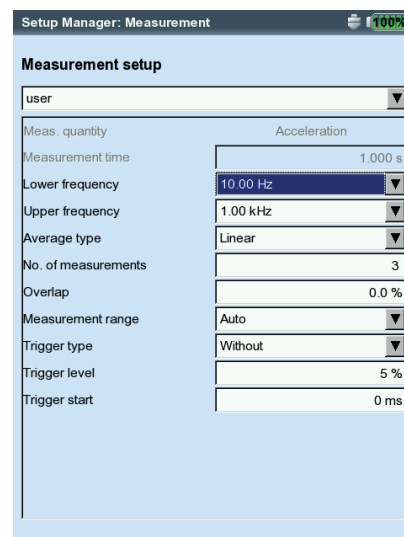

OVERLAP

Percentage by which consecutive measurements overlap.

Overlap = 0%, the total measurement time is: number of averages x measurement time;

Overlap > 0%, the total measurement time is accordingly shorter. For the runup / coastdown curve, the number of usable measurements can be increased by selecting a higher overlap.

TIME SYNCHRONOUS AVERAGING (PHASE, COASTDOWN, BALANCING)

In this type of averaging, the time signals of each individual rotation are averaged to reduce non-synchronous components in the signal. The number of time synchronous averages is either RPM-dependent (Auto), user-defined or unrestricted:

AUTO: Number of averages is a function of the rotational speed*.

MANUAL: Number of averages can be entered (max. 254).

UNRESTRICTED (only in meas. setup for balancing): Each individual measurement is averaged with the preceding individual measurement. The longer the measurement takes, the more stable the final result. This averaging type is used for balancing runs. The measurement must be stopped using the 'Enter' key.

* For example, time synchronous number of averages = 3, if speed \geq 120 rpm.

In coastdown setups only the numbers of averages can be set.

During a phase or an imbalance measurement VIBXPERT calculates a phase vector (amplitude and angle) from the time synchronous averaged signal. This procedure is repeated several times in order to increase the stability of the phase vector. The parameters for the phase averaging correspond to the settings under "Average type / Number of measurements" (see above).

ORDER (PHASE, COASTDOWN MEASUREMENT)

Order filter for the harmonic vibration components of the signal. For example, only the signal components of the 1st harmonic are filtered out and displayed by the first order filter. A half order is used for detecting oil whirls in machines with journal bearings.

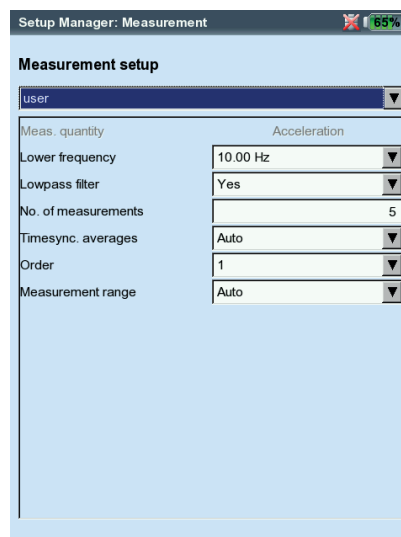

Measurement setup for phase

PULSE PER REV. (WITH RPM MEASUREMENT)

Number of measurement marks on the shaft or coupling.

MEASUREMENT RANGE (ALL VIBRATION MEASUREMENTS)

The measurement range for the analog channel can be automatically matched to the input signal ('Auto') or set to fixed*. When set to '[Value] / Auto-Up', the measurement range is automatically increased when the upper limit is exceeded.

LOW PASS FILTER (PHASE, AMPLITUDE COAST-DOWN - PHASE): To suppress high frequency noise signals, a low pass filter (1 kHz) can be activated (Yes). In a coastdown measurement the low pass filters (1 kHz / 10 kHz) are set automatically as a function of the start and stop speeds. With 'No', the signal is processed without a low pass filter.

NEGATIVE AVERAGING (IMPACT TEST)

Enables an impact test while the machine is running. The signals from the running machine are filtered out.

TRIGGER TYPE / LEVEL / START

(TIME WAVEFORM, VIBRATION OVERALL VALUE, USER AC, IMPACT TEST)

The measurement starts as soon as the signal has exceeded the selected trigger level (in % of the max. meas. range). Signal recording can be started before or after the trigger event via the Trigger start time.

START / STOP RPM (RUNUP / COASTDOWN)

Rotational speed at which the measurement should start or stop.

RPM DEVIATION (RUNUP/COASTDOWN)

The current, averaged measurement value is not saved until the rpm has changed by the value set here.

Deviation < Start RPM - Stop RPM

*'Fixed range', e.g. for a runup / coast-down curve or impact test.

Tip: Carry out a test measurement in order to determine the maximum amplitude.

Measurement setup for Runup/ coastdown analysis (phase)

Measurement setup	
Amplitude Coastdown Vel. 1500-300 rpm user	
Meas. quantity	Velocity
Lower frequency	2.00 Hz
Lowpass filter	Yes
Measurement range	Auto
Timesync. Averages	1
Start RPM	45.000 1/s
Stop RPM	5.000 1/s
RPM deviation	0.500 1/s

FILTER TYPE* (ENVELOPE)

SOFTWARE: Envelope calculation using a software algorithm.

* Parameter is fix

HP/LP FILTER* (ENVELOPE): 800 Hz / 10 kHz

DEMODULATION FACTOR* (ENVELOPE): 8

Ratio of the highpass frequency prior to demodulation to the low-pass frequency after demodulation.

NUMBER OF LINES (SPECTRUM*, IMPACT TEST)

Number of lines displayed. Together with the 'upper frequency', this parameter specifies the resolution of the spectrum (Δf).

WINDOW (SPECTRUM, IMPACT TEST)

The measurement of periodic signals generates time data sets with periodic gaps as a result of the finite observation period. Thus, the frequency lines appear wider in the corresponding spectrum. The window functions suppress these 'side lobes'.

Window features:

HANNING: Standard for FFT. Frequency precise, but amplitude errors (<15%); for the analysis of continuous processes with high frequency resolution and lowest possible leakage effect.

RECTANGULAR: Frequency errors, but amplitude is precise; suitable for the analysis of individual pulses, particularly if the pulse is at the beginning of the time window.

KAISER: AS with Hanning, but lower amplitude errors (<12%)

FLAT-TOP: Lower frequency accuracy than Hanning, amplitude more precise. For precision amplitude analysis of continuous processes.

HAMMING: Frequency errors as in Rectangular; amplitude errors (18%) less than in Rectangular, but higher than in Hanning.

BARTLETT: Next to Rectangular, this is the simplest window (triangle); lower amplitude and frequency accuracy.

BLACKMAN: As for Hanning, but with higher frequency accuracy; amplitude errors as in Kaiser (12%); next to Kaiser, the second best alternative for nearly all applications.

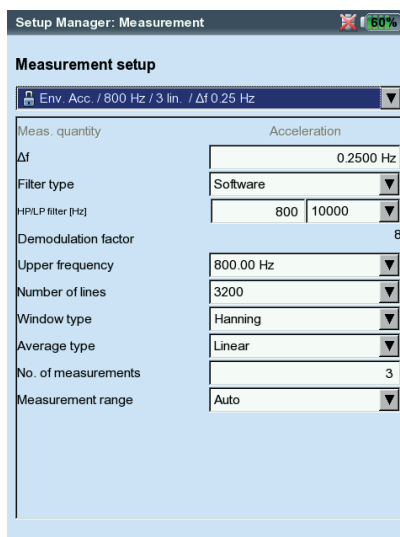

Setup for envelope spectrum
(Parameters are fix)

Transducer setup parameters



Note

If you have defined a default sensor for vibration measurements (see p. 2-22), the 'Sensor Setup' menu is deactivated.

MEAS. QUANTITY

Measurement quantity of the sensor: vibration acceleration, velocity, displacement, current, RPM, user-defined quantity

SIGNAL TYPE

Signal type of the sensor (e.g. LineDrive, ICP, voltage)

INPUT VOLTAGE RANGE

Voltage / current range for transducers of the signal type 'Voltage', 'Current', 'ext. 5V converter' and 'VIBREX/VIBRONET'.

QUANTITY / UNIT (USER DEF.)

Identification / Unit for a user-defined measurement variable.

PRECISION

Accuracy in decimal places.

COEFFICIENT A4, A3, A2

Parameters for linearizing a sensor's non-linear characteristic line (e.g. MNS12 proximity probe - VIB 6.640).

SENSITIVITY

The sensitivity of the sensor determines the signal level.

OFFSET / RESONANCE FREQUENCY

Offset and resonance frequency of the sensor.

LINEAR FROM / TO

The linearity range of the sensor and the filter setting of the measurement must be adapted to one another.

SETTLING TIME (RPM)

Settling time of the RPM sensor

Transducer parameters
for VIB 6.122 accelerometer

Sensor Setup	
VIB 6.122	
Meas. quantity	Acceleration
Signal type	LineDrive
Sensitivity	1.000 $\mu\text{A}/\text{m}/\text{s}^2$
Offset	0.00 μA
Linear from	1.00 Hz
Linear to	20000.00 Hz
Res. frequency	36000.00 Hz

C. Evaluation parameters for overall value / time waveform meas.

For characteristic overall value measurement tasks, which are measured according to ISO 10816-3, the corresponding thresholds are stored in fixed evaluation setups. For all other measurement tasks, create a user-defined evaluation setup.

- Activate the checkbox in front of the overall value.
- Select the limit value (see below).
- If necessary, change the names of the limit values.

To change the tab, press the '+/-' key or highlight this with the navigation keys.

Enter a description for the evaluation setup:

- Press the MENU button and click on 'Description'. A text field (initially empty) appears.
- Press the MENU button and click on 'Edit'.
- Enter the descriptive text in the text editor.
- After terminating the text input and closing the text editor, press the MENU button and click on 'Save'.

D. Parameters for RPM measurement

The RPM should always only be recorded if RPM-synchronous signals appear in the spectrum. In addition to the measurement, you can enter the speed by hand (not for phase measurement and balancing).

If you want to enter the RPM by hand before a measurement*, proceed as follows:

- Select the 'RPM measurement' menu and press the MENU key.
- Click on 'Edit' to open the task manager for the RPM task.
- In the 'Sensor Setup' menu, set the transducer to: 'Manual entry'.

Instructions on how to enter the RPM by hand after a measurement (spectrum only) can be found in the next chapter (see p. 3-21).

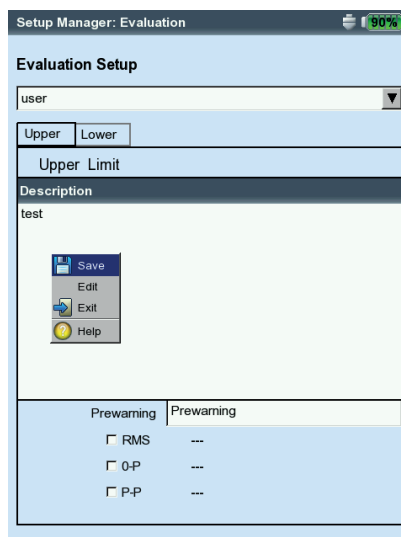
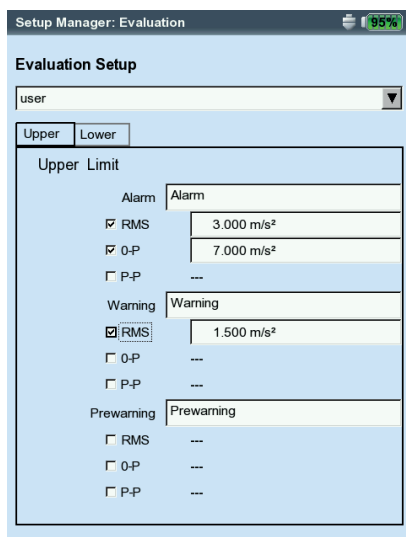
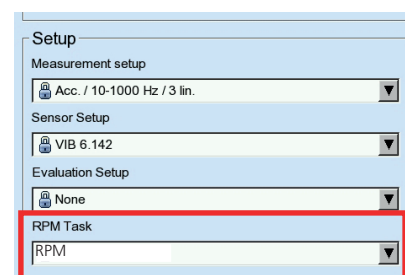
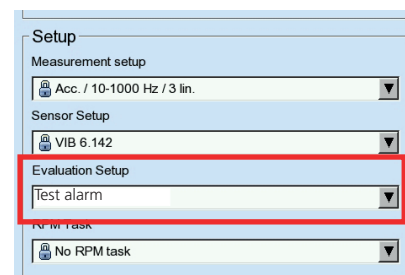

Left:
Evaluation parameters for overall values

Right:
Evaluation parameters description

* Import user-defined events via OMNI-TREND.

Entering an Event/Comment

You can record information relating to data collection using pre-defined events* and freely editable comments. Up to 10 events can be assigned to every measurement result.

Assigning an event

- In the result screen press the MENU key and click on 'Event/Comment' (see below). The event editor appears.
- Select the relevant event or events in sequence. The selection is listed in the lower event window.

Entering a comment

- In the event editor press the MENU key again and click on "Enter comment" (see below).
- Enter the comment and close the text editor. The comment is displayed below the event window.

Saving

- To save, press the MENU button and click on 'OK'.
A comment icon appears in the result screen next to the channel name. An event/comment icon appears in the tree/list view next to the route element (see below).



Note

Stored events and comments cannot be edited or deleted.

Left:
Enter comment

Right:
Open Event Editor

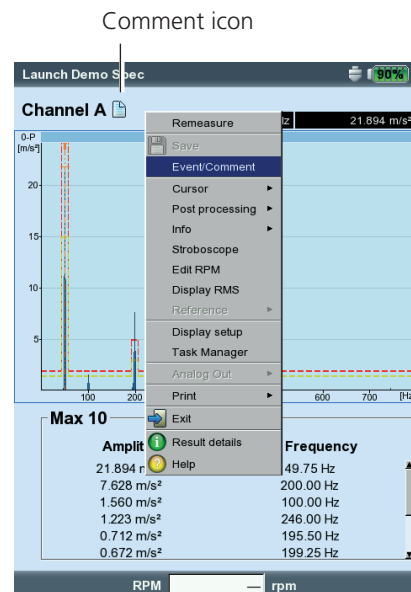
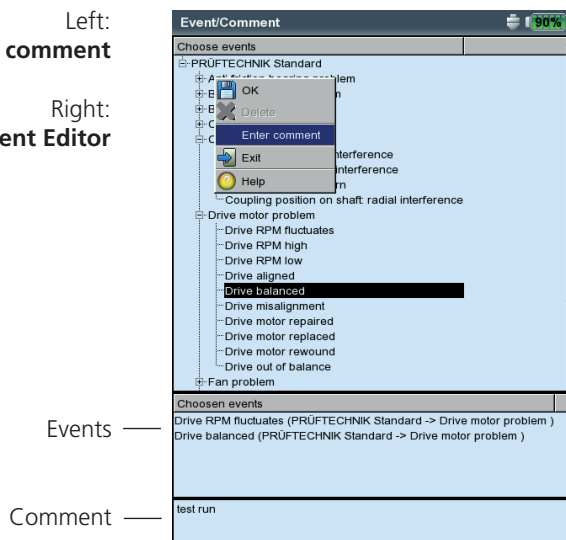

Trend

The standard procedure for monitoring machine conditions is the regular recording of characteristic overall values over a longer period of time. The trend of the machine condition can be traced back from the resulting trend curve and its probable development in the future can be predicted.

To obtain a meaningful trend, measurements must be carried out under always reproducible conditions - i.e. machine operating conditions, measurement location and sensors must be comparable or identical.

Starting / continuing a trend measurement

In order to perform a trend measurement, at least one measurement must already be stored.

- Click on 'File manager' in the start screen.
- Click on the file that was saved as a trend measurement.
- To start the measurement, either press 'Enter' or press the MENU key and click on 'Remeasure' (see below).
- After the measurement press the MENU button and click on 'Save'. Then the following message appears (see below):

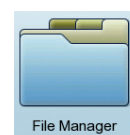

TASKS ALREADY MEASURED!

APPEND: The current result is added to the saved data set and extends the trend curve (see below).

OVERWRITE: The current result overwrites the already saved measurement data.

NEW: Create a new file. This is a simple method of adopting the settings of an existing file for a new measurement.

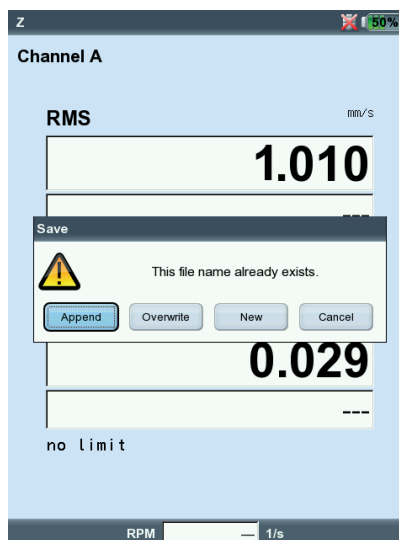
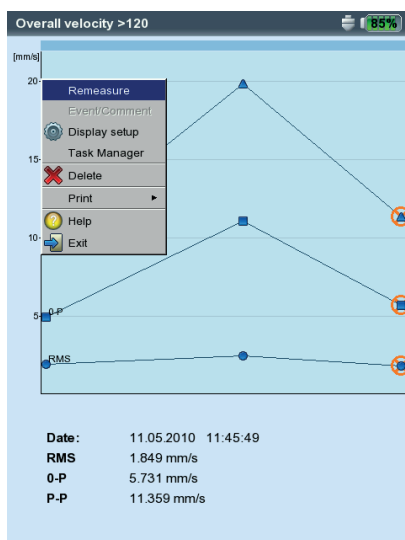

Left:
Starting a trend

Right:
Append current result

Results

After each measurement, it is possible to save the results and to evaluate them on the device. Numerous functions that can be called up with the MENU key in the results screen are available for this purpose (see below).

Result details

The following information can be displayed:

- Measurement Task, Measurement Channel, Measurement Range,
- Sensor Type, Date/Time, Status
- Statistical Data (for overall values only)



- Press MENU and click on 'Result Details'.

Characteristic overall value - single values

Up to two overall values are simultaneously displayed in the result screen. If the threshold values are exceeded during the measurement, these appear in the field below the respective measurement value (see below). Also, the respective LED lights up next to the display (see pages 2-2). Thresholds can be displayed as an absolute value or as a difference to the measurement value.



For vibration parameters with more than two overall values*, press the navigation key up / down to display the other values (see 'Display Setup', page 3-27).

* e.g.: Vibration parameters with 6 overall values:

1. rms value
2. 0-p value
3. p-p value
4. 0-p calculated ($= \text{RMS} \times \sqrt{2}$)
5. p-p calculated ($= 0\text{-p} \times 2$)
6. Crest factor (s. P. 5-1)

Left:
Result screen for overall value

Right:
Result details

RMS value
(no threshold value exceeded)

0-P value
(alarm exceeded by 1.387 mm/s)

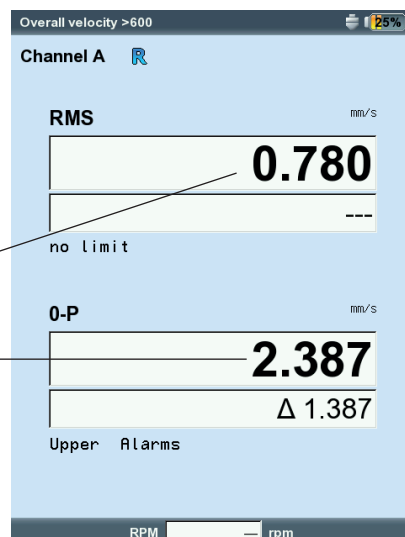

Result details	
Details	Values
Job	Velocity
Channel	A
Used range	75.000 m/s ²
Date/Time	11.05.2010 16:50:51
Status	Alarm
Statistic	
RMS	
MEAS	0.780
MIN	0.000
MAX	0.000
Standard deviation	0.000
0-P	
MEAS	2.387
MIN	0.000
MAX	0.000
Standard deviation	0.000
P-P	
MEAS	4.360
MIN	0.000
MAX	0.000
Standard deviation	0.000
Crest	
MEAS	3.060
MIN	0.000
MAX	0.000
Standard deviation	0.000

Characteristic overall values - trending

If more than two measurements are saved in a file, the results for each overall value are displayed as a trend curve.

Markers on the trend curve indicate each individual measurement. The measurement values at the cursor position, the date, the rpm if applicable, and assigned events and comments are specified below the diagram. Use the F key to display the individual results.

With the aid of the displayed threshold line, it is possible to determine if thresholds have been exceeded. If more than one overall value appears in the diagram, only the threshold for the highlighted value is displayed (in the below screen: upper alarm for RMS value). Press the navigation key up / down to mark the other overall values and display the respective threshold values.



Zoom

Press the '+' button repeatedly to magnify the area around the cursor. This process can be undone again with the 'Minus(-)' key.



The bars above a diagram show the displayed range relative to the entire display range.

Deleting individual measurements

If a spurious measurement has been included in the trend, delete this as follows:

- Highlight the measurement in the trend with the cursor.
- Press the MENU button.
- Click on 'Delete'.

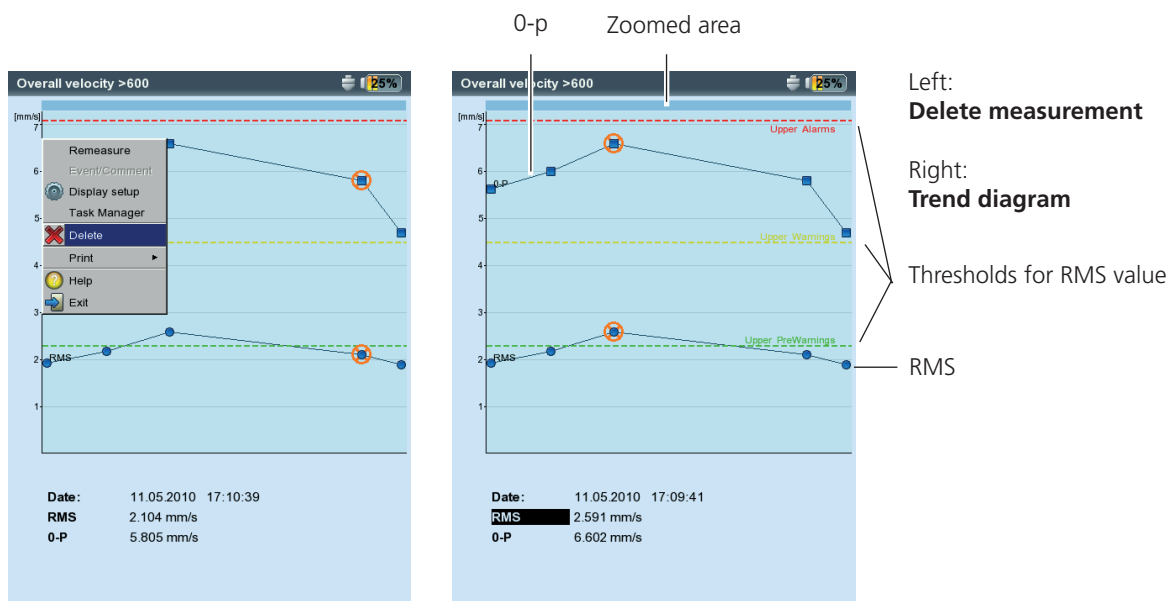

Vibration analysis: Results



Time waveform

The measurement results are displayed in the top section of the window. The data field in the lower half lists the two highest amplitudes (positive & negative). If a threshold value is exceeded, the absolute value and the difference to the measurement value is displayed ('delta', see below).

The following functions are available for evaluation of the result:



Zoom the time (X) axis

- Press the '+' key to magnify the X axis. Depending on the zoom mode, the main cursor is used as the central point or the gap between the main and delta cursor is magnified. The '-' key is used to zoom out.



Scaling the amplitude (Y axis)

- Press the navigation key up to magnify the scaling of the Y axis and to make low amplitudes visible.
- To reduce the scaling again, press the navigation key down.

Rotational speed marker

The yellow rotational speed markers indicate the trigger pulses during signal measurement. In the circular plot, the speed markers also indicate the direction of rotation (see the next page).

Cursor

The cursor coordinates are displayed above the diagram.

- Press the MENU key and click on 'Cursor'.

NONE: Hide all cursors (Zoom / scaling not possible!)

MAIN: Show main cursor

Press the navigation keys right/left to move the cursor. The speed increases if you keep the navigation key pressed.



Result screen of a time waveform measurement

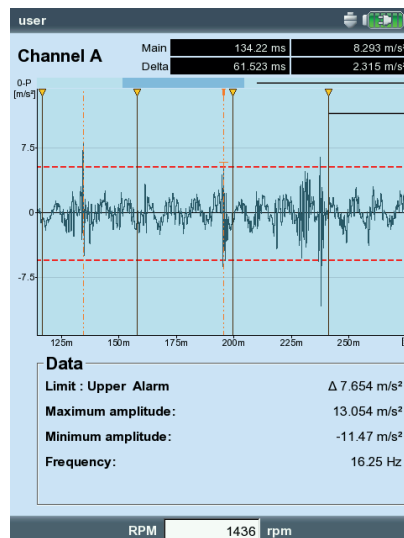

- Cursor coordinates
- Zoomed area
- Speed marker
- Threshold

DELTA: Show/hide delta cursor

Press 'Enter' to switch over between main and delta cursor. In this case the measurement can only be repeated via the MENU key (MENU - 'Remeasure')! The cursor coordinates indicate the distance to the main cursor. The data field specifies the frequency which corresponds to the distance between the main and delta cursor (see below).

SIDEBANDS: Show/hide sideband cursor

Select the number of sidebands. The spacing of the sidebands is set by moving the outer cursor*. The position of the entire group can be changed by moving the middle (main) cursor.

* press 'Enter' to switch between the main and the outer cursor.

Cartesian / circular plot

By default, the time waveform is displayed in a Cartesian plot (XY diagram). However, you can change the display to a circular plot. This is useful when the gear mesh in a gear stage is to be emphasized, for example. In this type of display, the measured time interval is projected on a circle, so that the start and end times are directly adjacent to one another. If the shaft rotates by 360° within the measured time interval, the circular diagram shows the signal for one complete rotation of the shaft.

- Press the F key to toggle the two diagram types.

F

Characteristic overall values

The following overall values can be calculated from the time waveform:

- Maximum / minimum amplitude,
- Arithmetic mean, p-p value, RMS value, Crest factor.

- Press the MENU key in the result screen.
- Select 'Postprocessing' and click on 'Compute overall values'.

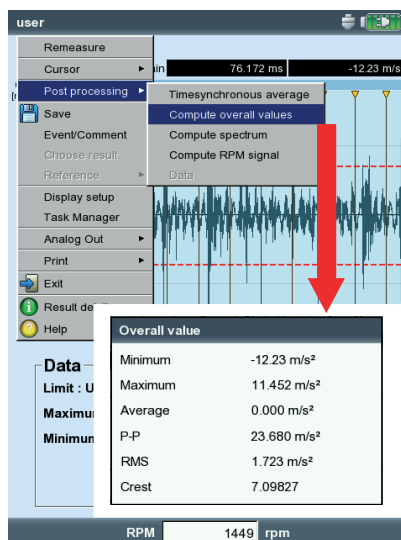
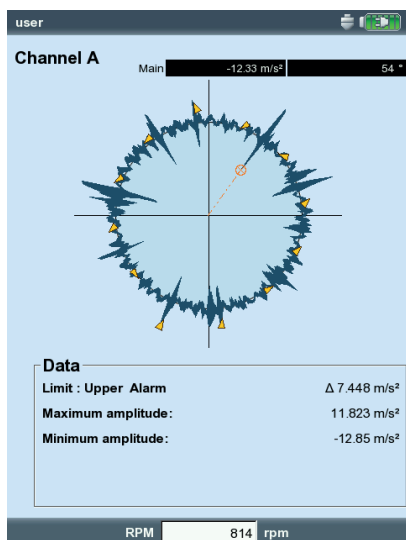

Left:
Time signal in circular plot

Right:
Signal postprocessing

Vibration analysis: Results



Amplitude / Envelope Spectrum

The spectrum is displayed in the upper pane. After the measurement, additional data can be displayed in the lower window pane.

- Press the MENU key.
- Select 'Info', and click on the desired data set.

Info / Max 10

Lists the 10 highest amplitudes in the spectrum. Click on an entry to set the cursor to the corresponding line of the spectrum. You can sort the list for amplitude or frequency in ascending or descending sequence. To do so, click on the respective column title.

Info / Time waveform

The signal can be shown in the lower window pane for test purposes. The Zoom function is available for signal evaluation.

Info / Cursor

Enable the 'Cursor' option when working with the harmonic/subharmonic cursor or with the sideband cursor.



Note



The data to be displayed by default after the measurement is set in the display setup (see p. 3-28).

The active window pane is highlighted by a frame. Press the F key to switch to the other window pane.

Zoom / Scaling See 'Time waveform', page 3-18.

Left:
Spectrum & time waveform

Right:
Additional information

Upper window pane is active

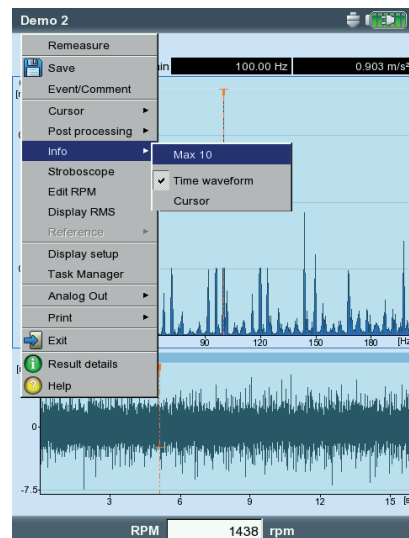
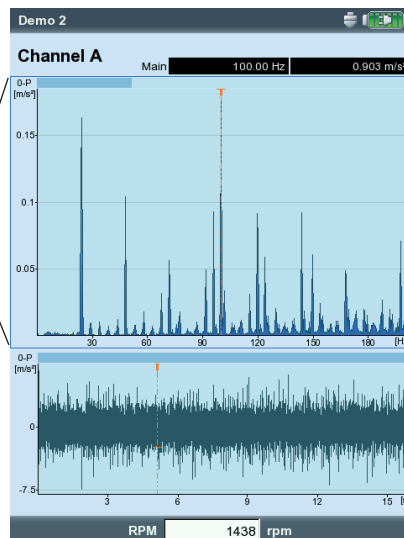

Stroboscope

Enable this feature if you want to control a strobe light with the frequency at the main cursor position. Move the cursor in the spectrum, to change the flash rate.

You can use a strobe light to visually slow the movement of an object, making it easier to analyze, check for proper procedures and find undesirable vibration sources. By visually 'freezing' the movement, you can precisely determine the rpm or the alternating frequency.



Note

To connect the strobe light to the yellow port, use the adapter available as an accessory (VIB 5.333).

Set RPM

After a measurement, you can either enter the machine RPM directly or read it in via the marked frequency in the spectrum. Press the MENU button, click 'Set RPM' and select the desired option (see below).

Display RMS

Calculate the RMS value of the spectrum (see below).

Post processing

Each spectrum is initially calculated from the measured quantity (i.e. acceleration). Post-processing alters the measurement quantity in the spectrum (e.g. velocity into displacement).

Find peak

Calculation of the 'probable' frequency at the cursor position in case of a spectrum with insufficient resolution.

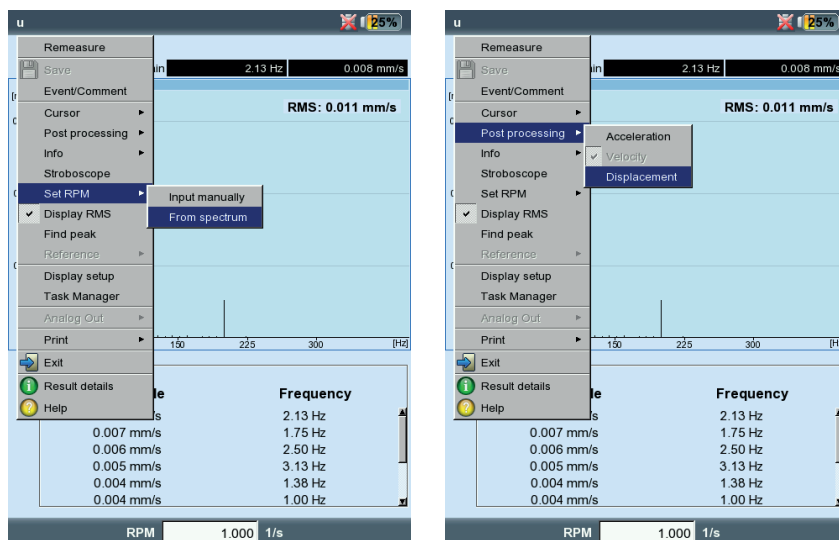

RMS value

Left:
Enter the machine RPM

Right:
Post processing
(select meas. quantity)

Vibration analysis: Results

Cursor

- Press the MENU key and click on 'Cursor' (see below)

NONE /MAIN / DELTA: See 'Time waveform', page 3-18.

HARMONICS: The harmonic cursor is used to assign harmonics in the spectrum. The spacing of the individual cursors to one another corresponds to the basic frequency at the main cursor. To adjust this, the main or the delta cursor (highest displayed order) can be moved.

- Adjust the required number of the cursors.

SUBHARMONICS: The subharmonic cursor can be used to detect subharmonics in the spectrum. The spacing of the individual cursors to one another corresponds to a integer fraction (1/n) of the main cursor.

- Adjust the required number of the cursors.



Note

If the subharmonic cursor is activated, the delta cursor is not active.

SIDEBANDS: Show/hide sideband cursor

The sideband cursor can be used to identify modulations of a carrier frequency. The distance of the sidebands can be set by moving the outer cursor*. Change the carrier frequency by moving the main cursor.

* press 'Enter' to change over

- Adjust the required number of the cursors.

Left:
Spectrum, Cursor menu

Right:
Spectrum, Harmonic cursor

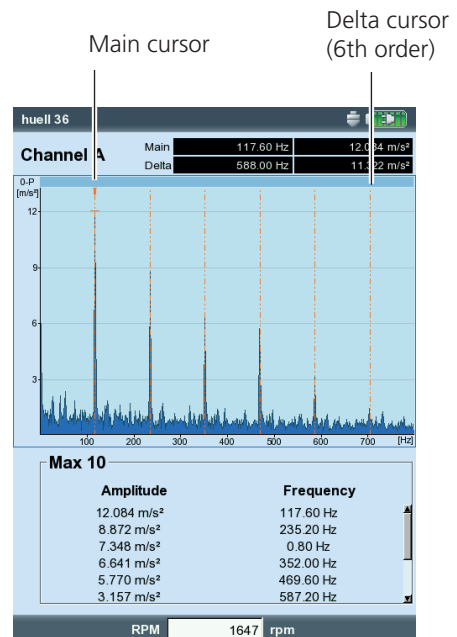
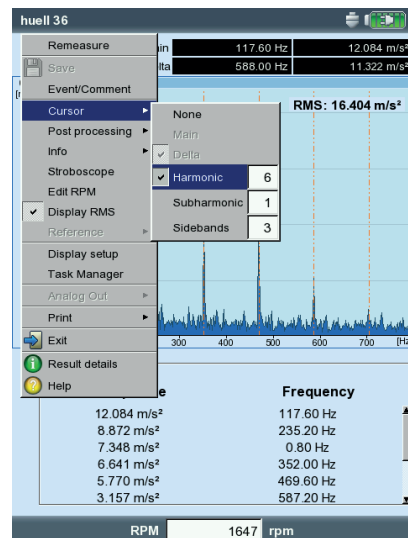

3D display of spectra: Waterfall diagram

If several spectra were recorded for one measurement task (max. 75), these appear in a 3-dimensional diagram - the waterfall diagram.

Navigation

 Navigate through the individual spectra.



 Move the cursor along the frequency axis.

Change view

To rotate the waterfall diagram change the display mode:

- Press the MENU key and click on 'Resize display field'. Use the navigation keys to do the following:

 tilt the diagram around the frequency axis.



 rotate the diagram around the amplitude axis.

This display mode is indicated by the icon shown right.



Cursor

Only the main and delta cursors are available for evaluation in the 3-D view. To activate the delta cursor, press the MENU key and click on 'Cursor > Delta'.

Zoom

The Zoom function can be used in the Waterfall diagram along the frequency axis (=X) as well as along the Z-axis. The amplitude axis (=Y) cannot be scaled in the 3-D view.

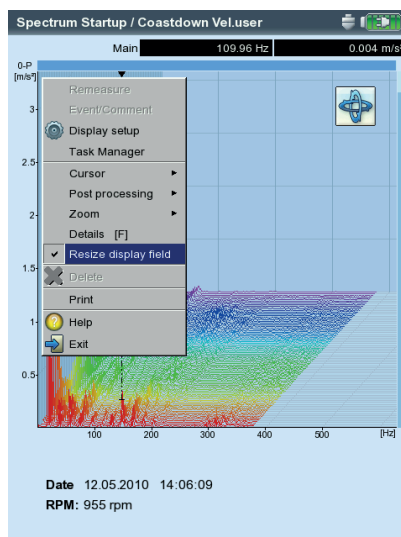
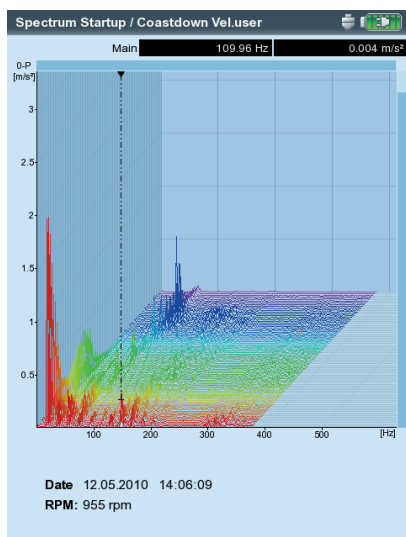

Left:
Waterfall diagram

Right:
Rotate / Tilt diagram:
Use the navigation keys in the  node

Vibration analysis: Results

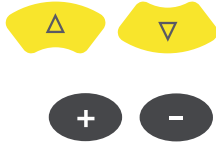

Which of the two axes (X or Z) can be zoomed is displayed by a flashing bar along the edge.

- If the right bar flashes, the Z-axis can be zoomed with the navigation keys.
- If the upper bar flashes, the X-axis can be zoomed with the + / - key.

To change the active axis, press the MENU key and click on 'Zoom > X-axis' or 'Zoom > Z-axis'.

Evaluating individual spectra (2D view)

For the evaluation of an individual spectrum, proceed as follows:

- Highlight the relevant spectrum with the cursor.
- Press the F key to display the individual spectrum.
Alternative: Press the MENU key and click on 'Details'.
- Call up the respective diagnosis functions with the MENU key.

F

ESC

To return to the 3D view again, press the ESC key.

Zoom

Zoom in on the frequency (X) axis when the upper bar flashes

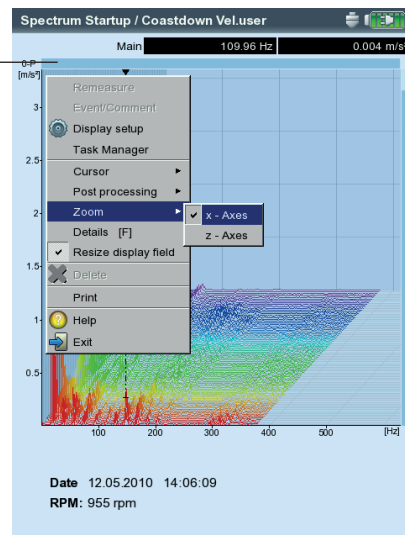

Sound spectrum: third-octave and octave level diagram

VIBXPERT makes the sound spectrum available for the display and evaluation of acoustic signals. The signal picked up by the microphone is broken down in the frequency domain into bands with a constant relative band width (octave bands or third-octave bands). To quantify the volume, VIBXPERT specifies the sound pressure level of each band as well as the overall sound level. Depending on the overall level, four evaluation filters (A, B, C, D) can be set to take into account the human perception of volume. Since the sound pressure level is a logarithmic quantity, a reference value is needed to calculate it. This value must be entered as well.

The sound spectrum can only be selected for amplitude spectra with the vibration acceleration, vibration velocity and vibration displacement quantities, as well as for user-defined quantities. Envelope spectra cannot be converted into sound spectra.



Note

Displaying the sound spectrum

To display an amplitude spectrum as a sound spectrum, proceed as follows:

In the Multimode selection screen:

- Mark the measurement quantity for the amplitude spectrum.
- Press the MENU button and click on 'Display Setup/Measurement'.

In the measurement screen:

- Press the MENU button and click on 'Display Setup'.

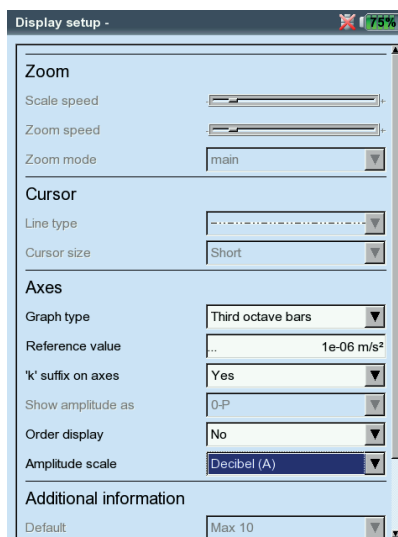
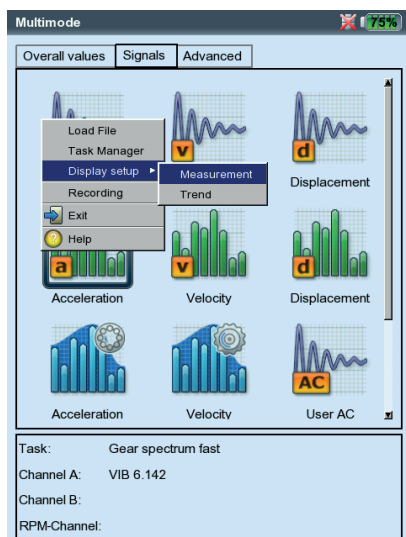

Left:
Open Display Setup (Multimode)

Right:
Sound spectrum settings
Graph type, reference value, amplitude scale

Vibration analysis: Results

- Select 'Third-octave bar' or 'Octave bar' for the graph type.
- Set the 'reference value' needed to calculate the sound pressure level (for example, for airborne sound $p_0 = 20 \mu\text{Pa} = 2 \times 10^{-5} \text{ Pa}$).



Note

The reference value unit corresponds to the measurement quantity set in the spectrum. The unit can only be changed for user-defined quantities.

- Set a suitable evaluation filter (decibels (A),(B), (C) or (D)). If you do not wish to evaluate the sound pressure level with a filter, set 'decibel'.
- Then press the MENU button and click on 'Save'.

The individual frequency bands (third-octaves, octaves) appear in the sound spectrum, as does the overall sound level in a logarithmic scale. The lower Info field specifies the sound pressure levels of the individual bands. The cursor and zoom functions are not available in this display.

Sound spectrum

Evaluated sound pressure level in dB (A)

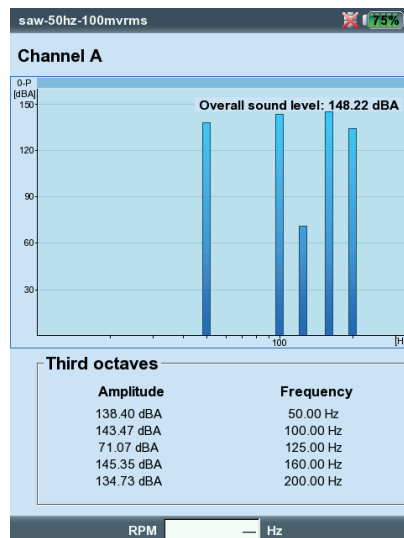

Display Setup

In the Display Setup you set up the view in the results screen. You can open the setup before or after the measurement:

In the Results screen, after a measurement:

- Press the MENU key and click on 'Display Setup'.

Before a measurement, in the task selection screen (see below):

- Highlight the measurement task symbol.
- Press the MENU key and highlight the 'Display Setup' entry.
- Press the navigation key right and click on 'Measurement' or 'Trend' respectively (see below).

Depending on the measurement type you can set the following parameters:

X. Continuous measurement ('live mode')

In 'Live mode', you can check the signal quality before beginning with data collection.

A1. Display Setup for measurement: Overall values

DISPLAY LIMIT AS...: The limit values can be displayed as an absolute value or as a difference ('Delta value') to the measurement value.

DISPLAY OVERALL PEAK VALUE: Select the characteristic vibration value that is to be displayed by default with the 'RMS value'. After the measurement, press the navigation key up repeatedly to display the overall values of the series that were not displayed. If the threshold value is exceeded, the RMS values and the overall value that exceeded the threshold value by the largest amount are displayed.

A2. Display-Setup for Trend: Overall values

MEAS. VALUE: Selection of overall values. The line type can be selected and the labeling can be shown for each trend curve.

SHOW...: Limits, event markers, references and the associated labeling can be displayed in the chart. The line type can be selected.

Display Setup

for overall values with more than two quantities.

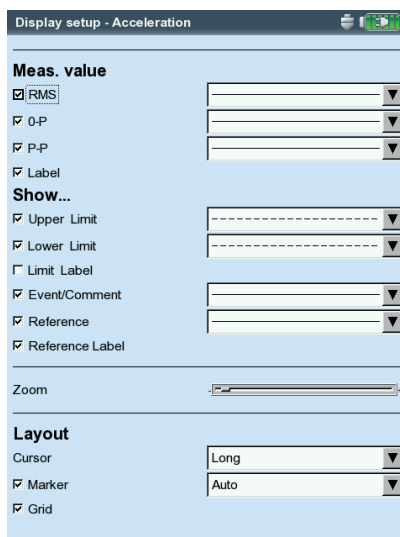
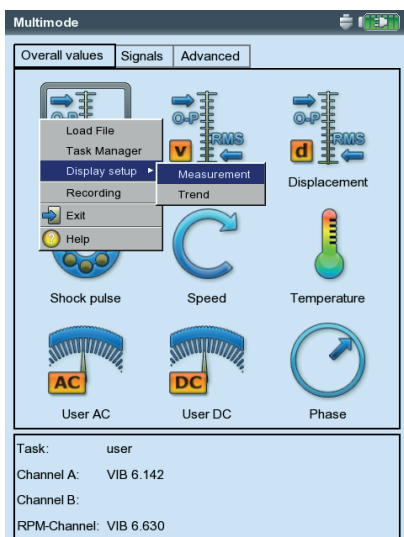
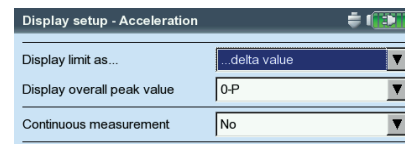

Left:
Opening the Display Setup
before a multimode measurement

Right:
Display Setup for Overall Trend

Vibration analysis: Display setup

ZOOM: Speed or step size when zooming

LAYOUT: The values on the trend curve can be identified with markers. A grid can be displayed for easier evaluation of the data and the cursor can be displayed as a cross (short) or line cursor (long).

B1. Display Setup for measurement: Spectrum / Time waveform

ZOOM: Step size when zooming the X and Y-axis.

Zoom Mode: The zoom is made around the main cursor or the gap between the delta and main cursor.

CURSOR: Cross (short) or line cursor (long); line type for the line cursor

GRAPH TYPE: A spectrum can be displayed in a curve diagram ('continuous') or a bar chart ('poles'). 'Gradient' colors the area under the graph. For a sound spectrum select the 'octave' or the 'third octave' option. A time waveform can be displayed in Cartesian coordinates (X-Y diagram) or on a circular plot. When taking measurements with DC coupling, the DC component in the signal can be hidden (Option: 'AC only').

SUFFIX FOR 1/1000 OR 1000: Instead of '1/1000' or '1000', the X-axis can be labeled with the abbreviation 'm' (milli) or 'k' (kilo).

AMPLITUDE (SPECTRUM): Amplitudes in RMS or peak values (0-peak, peak-peak). RMS value of entire spectrum: see p. 4-11.

ORDER DISPLAY (SPECTRUM): Scaling of the X-axis in Hz (No) or orders (Yes). The shaft RPM must be known (measured or entered).

AMPLITUDE SCALING (SPECTRUM): linear or logarithmic (in decibels).

DEFAULT DISPLAY MODE (SPECTRUM): Information that appears in the lower pane by default (Max 10, time waveform, band alarms, frequency marker, trending parameters, cursor coordinates).

SPEED MARKER (TIME WAVEFORM): Display of the trigger signals in the diagram. In the circular plot, the arrow indicates the direction of rotation.

Left:
Display setup for time waveform

Right:
Display setup for spectrum

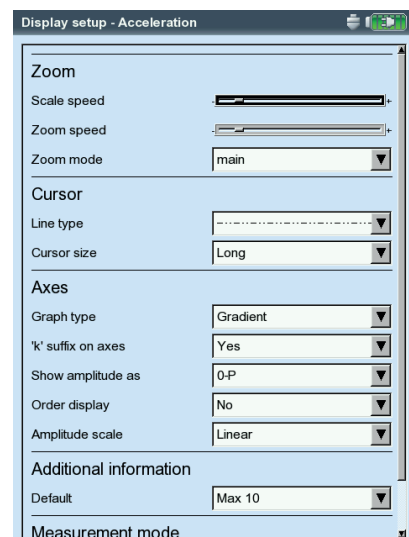
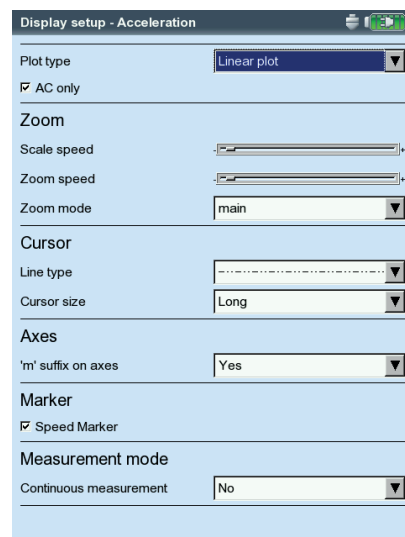

B2. Display Setup for Trend: Spectrum (Waterfall diagram)

CURSOR & AMPLITUDE: s. section B1; in a waterfall diagram, a grid can be superimposed for easier evaluation of the data.

C1. Display Setup for measurement: Coastdown, Orbit, Phase

The following sections C to E only describe the parameters specific to the measurement type. Global display parameters, such as 'Zoom' and 'Cursor', can be found in sections A and B.

SHOW OVERALL (COASTDOWN - OVERALL VALUE): The results screen displays the RMS value and one of three peak values in dependence on the RPM. Select the peak value (0-peak, peak-peak, crest) which is to be displayed as standard.

PLOT TYPE (COASTDOWN - PHASE): The runup / coastdown curve can be displayed as a Bode or Nyquist plot.

SHOW AMPLITUDE AS (COASTDOWN CURVE - PHASE VECTOR): Amplitudes can be displayed as an RMS value or a peak value (0-p).

CONTINUOUS PHASE (COASTDOWN - PHASE WITH BODE PLOT): The scale of the phase axis begins at 0° and ends at 360°. If the curve runs beyond the 360° mark during the measurement, it is continued unchanged at 0° (No). If you select the Yes option, the phase axis continues beyond 360° - beginning again at 0° - and the phase progression is continually displayed (see page 3-40).

C2. Display setup for trend: phase

PHASE OVER...: When several phase measurements are saved in one file, the phase vectors can be shown depending on the time or rpm (see below).

Phase trend diagram

Press the F-key to open a menu in the results screen:

DETAILS:	Show result of a single measurement
NYQUIST / BODE:	Change diagram type
SHOW CHANNEL:	Show channel A, channel B or both channels.

F

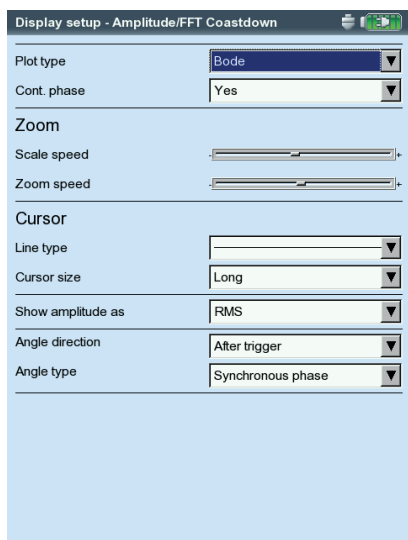

Left:
Display setup for Coastdown
(Phase-RPM)

Right:
Phase trend
Phase vector as a function
of the rpm (see figure) or the time

Reports

The print function in VIBXPRT enables printouts of the following reports:

- Screenshots
- Measurement reports

To be able to print directly on a printer from VIBXPRT, you require:

- A printer with USB connection
- A VIBXPRT USB printer cable (VIB 5.330 MUSB, accessory)

Reports in PDF format can be transferred to a PC, where they can then be printed. The following options are available for this function:

- Data transfer via VIBXPRT Utility Program (p. 5-8f.).
- Load PDF file via USB adapter to USB pen drive (p. 3-33).

With the VIBXPRT Utility Excel Report Module (VIB 8.986), which is available at extra cost, you can export measurement data in MS Excel format for processing on a PC (S. 3-34).

Preparations for direct printing

- Connect VIBXPRT to the printer (see p. 2-22).
- Set up the printer in the VIBXPRT device setup (see p. 2-21).
- Print out the results (see the following sections)

Printing the content of a result screen

- In the result screen, press the MENU key.
- Click on 'Print', or select 'Print' / 'Screenshot' (see below left). The printer selection dialog window appears.
- Select the printer.
- Press the MENU key and click on 'Print' (see below right). If you select 'PDF' as the printer, enter a file name in the text editor. The printer icon appears at the top edge of the screen while the print job is being processed. The screen printout is scaled to half the page width and is positioned in the middle of the page.

Left:
Print screenshot

Right:
Selecting the printer
and start printing.

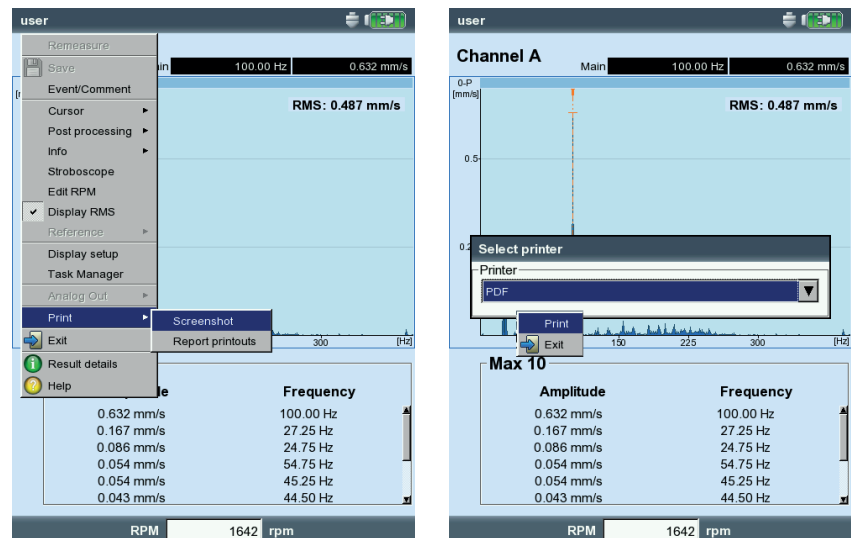

Measurement reports

A measurement report is used to create detailed documentation on a measurement. The report contains the results, general information on the operator and additional measurement information. Measurement reports are available for the following measurements:

SPECTRUM, TIME WAVEFORM, OVERALL VALUES TREND, BALANCING.

Configuring the measurement report

Which information is contained in the measurement report is defined in the report configuration. Every measurement has a standard report configuration that is adequate for most cases. The standard configuration can be neither edited nor deleted. To create a new report configuration, proceed as follows:

- Press the MENU key in the result screen.
- Select 'Print' and click on 'Report printouts'.
The report configuration appears (see below).
- Select the 'Reports' field.
- Press the MENU key and click on 'New'.
- Enter a name in the text editor.
- In the 'Common settings' tab, select the entries that are to appear in the measurement report:

COMPANY: Company name that appears on the report. To change it, click on the text field. The changed company name is used in all report configurations.

LOGO: Company logo that is printed in the report. Transfer the new logo using the 'VIBXPERT utility' program (see p. 5-7). File format: PNG, image size: max. 186 pixels (longest side).

CUSTOMER: The customer information is stored globally and can be accessed by any report configuration. Select the customer from the menu.

Left:
Report configuration
General information

Right:
Report configuration
Information on the spectrum specific to the measurement type

Create a new customer as follows:

- Open the customer selection menu and click on the lowest entry, <Edit>. The customer list appears.
- Press the MENU key and click on 'New'.
- Enter the customer data in the text editor.

INSPECTOR/ASSET: Information on the inspector/asset. Click in the corresponding text field to edit the information.

RESULT FILE NAME: The result file name appears in the report.

REPORT EVENT: Report-specific event. Click in the text field to open the event editor and select the event.

RESULT EVENT: Here you can only set whether or not events should be printed.

SETUP INFO: Information on the measurement settings to be used. Three options are available for selection:

- Standard: The name of the measurement and sensor setup is printed.
 - Standard + evaluation: Like Standard, plus evaluation setup or machine setup*.
 - Details: Like Standard + evaluation, plus a screen printout of each setup.
- In the 'Measure info' tab, select the measurement type information that is to appear in the measurement report (compare example on previous page).

* only for balancing reports

Printing out the measurement report

- Select the printer and the report configuration ('Printer' or 'Reports' field).
- Press the MENU key.
- Click on 'Print' (see below).

If you select 'PDF' as the printer, enter a file name.

Left:
Printing out the
measurement report

Right:
Measurement report
for the spectrum

The screenshot shows a software window with a 'Rep' menu open, displaying options: Print, Save, PC, New, Delete, Re, and Exit. Below the menu is a 'Report Spektrum' dropdown. The 'Measure info' tab is active, showing a 'Common settings' section with checkboxes for Company, Logo, Customer, Inspector, Asset, Result filename, Report event, Result event, and Setup info. The 'Setup info' dropdown is set to 'Standard'. The 'Company' field is 'Prüftechnik Condition Monitoring Gmb...', 'Logo' is 'pruftechnik', and 'Result filename' is empty.

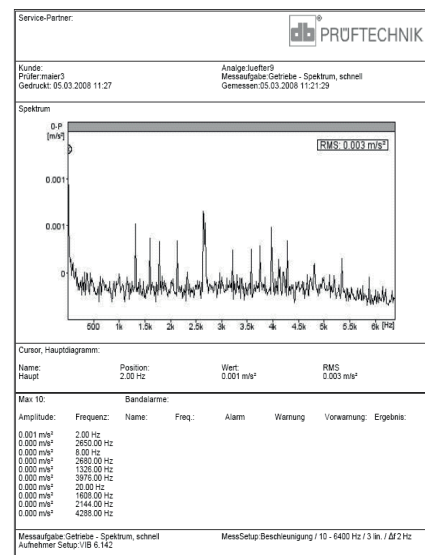

Loading reports onto USB pen drive

Reports in PDF format can be transferred to a USB pen drive and then to a PC, where they can then be printed.

To do this, you need the following:

- Cable for USB pen drive - VIB 5.330AMEM
- USB pen drive - VIB 5.350-USB

Connect the cable to the communication channel (green jack). In the file manager, the USB pen drive is shown as a separate directory 'USB'.

To transfer the report:

- Mark the file.
- Press MENU and click 'Copy' or 'Move'.
- Mark the directory 'USB'.
- Press MENU and click 'Insert'.

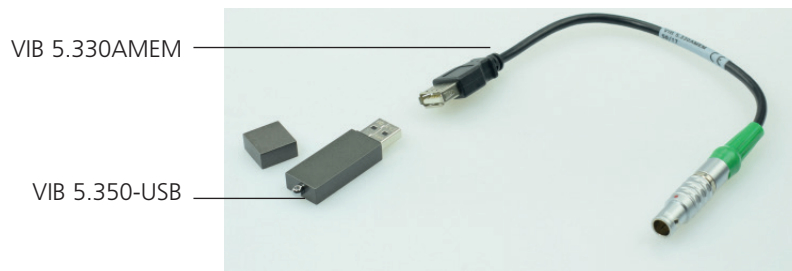

Exporting measurement data in MS Excel format

- Exportable measurement data:
Overall value, FFT spectrum, balancing result, time waveform, coast-down measurement (amplitude phase and overall value), 2-channel measurements
- Compatible version: MS Excel 2003, MS Excel 2007
- Connect VIBXPRT to the PC.
- Start the VIBXPRT Utility Program and register the report module (see p. 5-6f.).
- In the utility startup screen, click 'Transfer files' and then 'CSV Export'.
- Mark the measurement file and click 'Export *.xls'.

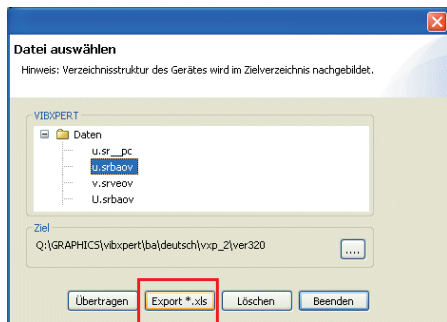
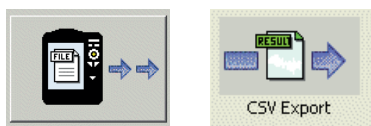

Below:
Measurement data in Excel format

The measurement data are then exported and the MS Excel program is started. The report templates contain macros, which normally are blocked by the program at first.

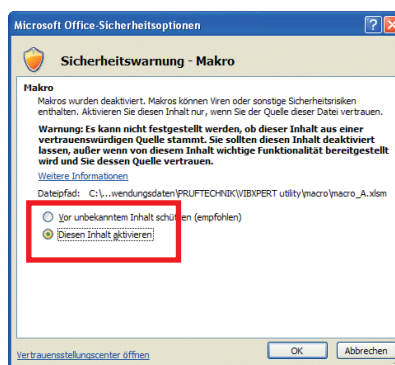
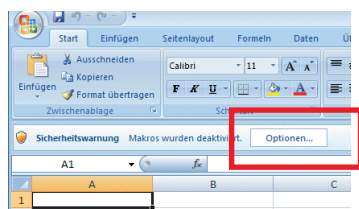
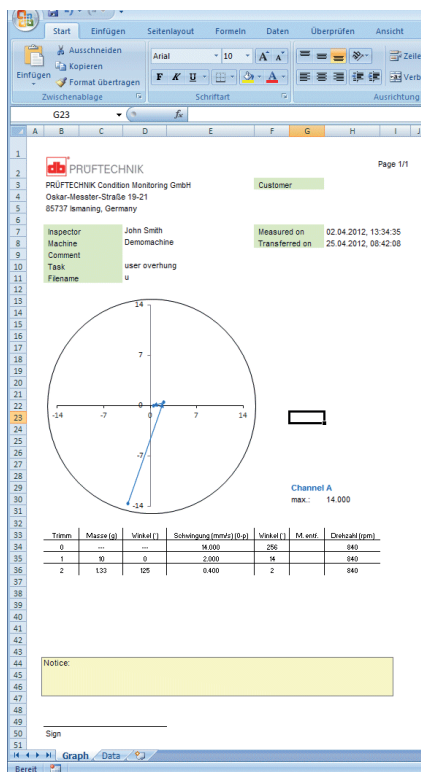

- In the security warning, click 'Options' and activate the option 'Activate this content'.

Excel then displays the measurement data on two worksheets:
1st worksheet: Displays the master data for the measurement and the measurement diagram.
2nd worksheet: Contains the readings in table form

The generated Excel files are based on templates, which can be adapted as necessary by a user with the corresponding skills.

Measurement tasks

This chapter contains information on the individual measurement tasks and tips for carrying out a measurement.

Characteristic overall vibration values

Characteristic overall vibration values are used for evaluating machine, bearing and gear conditions. A good indicator of the vibration forces acting on a machine is the effective value (RMS) of the vibration velocity in the frequency range 10 - 1000 Hz or 2 - 1000 Hz. Evaluation criteria of the permissible vibration levels are specified in the ISO 10816-3 norm (see below). These ranges are preprogrammed in VIBXPRT in the form of threshold values and can be called up in the Evaluation Setup.

As well as the effective value of the vibration, VIBXPRT records the highest signal amplitudes as peak values (0-peak, peak-peak) and calculates the crest factor from these.

What is the crest factor?

The 'Crest Factor' is the ratio of the highest amplitude to the effective value (RMS) of a vibration and is a measure of the intensity of the impacts in the form of a vibration. Among other things, the crest factor is deployed for wear diagnosis in roller bearings and gearing mechanisms as well as for cavitation. A harmonic vibration of amplitude '1' has 0.707 as its effective value and a crest factor of 1.41. If the crest factor is higher than 1.41, impacts with higher amplitudes are occurring.

ISO 10816-3 for the assessment of machine vibrations

To assess the machine condition, the machine is first assigned a machine group with the aid of the lower axis. The range in which the measured effective value falls can be read from the axis at the side.

Overall vibration values

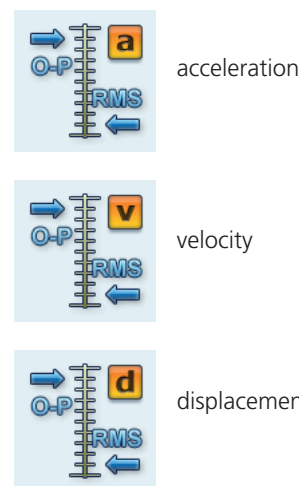

VIBXPRT II Balancer 12.2019

				11	0,43	Vibration velocity (r.m.s.) (10 - 1000 Hz n > 600 min ⁻¹) (2 - 1000 Hz n > 120 min ⁻¹) mm/s inch/s
				7,1	0,28	
				4,5	0,18	
				3,5	0,14	
				2,8	0,11	
				2,3	0,09	
				1,4	0,06	
0,71	0,03					
rigid	soft	rigid	soft	Foundation		
med. sized mach. 15 kW < P < 300 kW		large machines 300 kW < P < 50 MW		Machine type		
Motors 160 ≤ H < 315 mm		Motors 315 mm ≤ H		Machine type		
Group 2		Group 1		Group		

What you need to do:

Range A: Continue to measure at regular intervals.

Ranges B,C: Look for the cause of the vibration. Observe the machine closely. Schedule a power down.

Range D: Take immediate measures: Localize the cause, switch the machine off and remedy the problem.



* If shaft speed $< 0,1$ Hz (= 6 rpm), then change the 'Keyphaser - Timeout' setting in the Device setup (p. 2-17).

RPM measurements

The Laser-Trigger Sensor (VIB 6.631) is used for RPM measurement and as a trigger encoder. The sensor detects the signals optically, i.e. without contacting rotating machine parts during the measurement. Red laser light is emitted from the sensor head and strikes a measurement mark on the rotating shaft. The measurement mark can be light amplifying (e.g. reflective film VIB 3.306) or light attenuating (a black, high contrast line on a light-colored surface). Each time the sensor detects a difference in brightness, it sends an electric impulse. VIBXPERT calculates the shaft RPM* based on the repeat rate of the pulses.



Laser-Trigger Sensor (VIB 6.631)

Typical installation for a vibration measurement with simultaneous recording of the rotational speed.

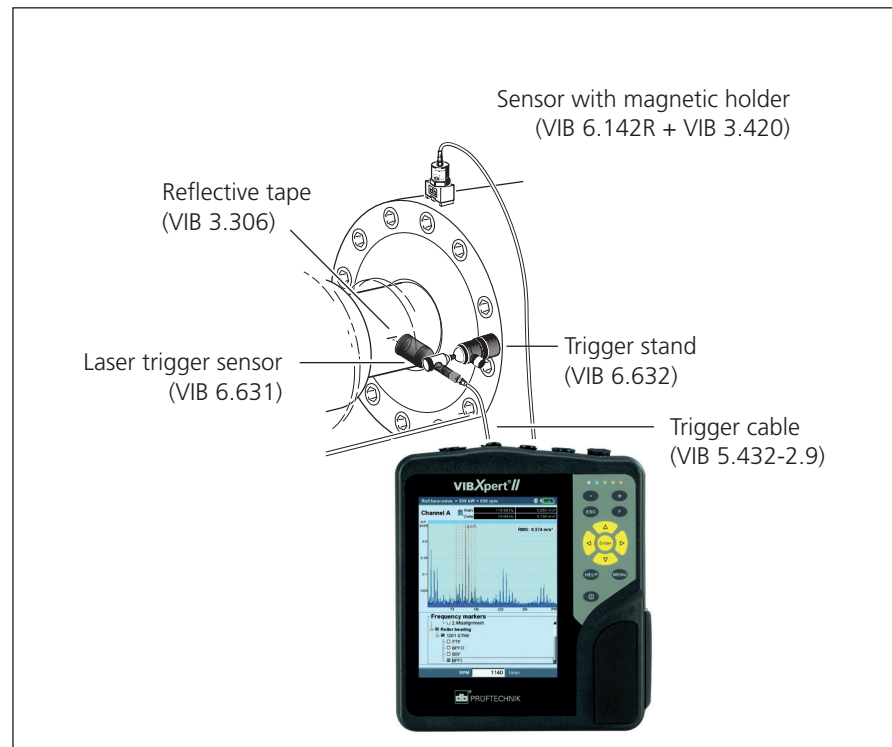

Temperature measurement

For temperature measurements thermocouple type K sensors such as the VIB 8.608 handheld probe or the VIB 8.607-1.5 sensor with magnetic holder can be used.

Tips for measuring

- Hold the sensor at the measurement location until the sensor has recorded the temperature of the measurement object.
- If the values vary, repeat the measurement or increase the number of averages in the measurement setup.
- VIBXPERT does not carry out any sensor detection on the measurement channel for temperature. If the results are not correct, check the connection and the sensor cable.

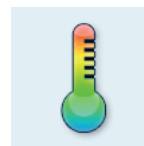

Measurement range:
 VIB 8.608: -50°C to 500°C
 VIB 8.607: -50°C to 240°C

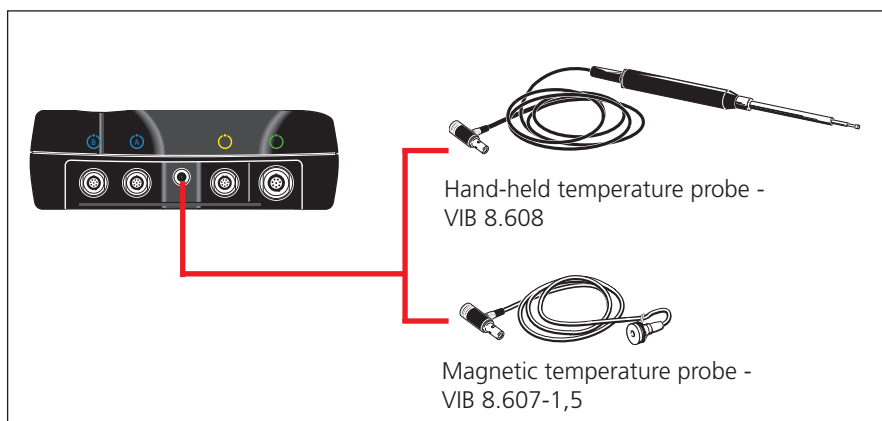

Temperature probes

(Type K thermocouple, technical data are given in the sensor catalog)

Runup / Coastdown

The runup and coastdown curves record the changes in the vibration behavior of the machine when it starts up or shuts down. This analysis function can be used to determine the resonance frequencies of a machine. The following measurement types are available:

- Phase vector (amplitude and angle), dependent on the RPM
- Overall value, dependent on the RPM

Runup

Measurement is started *before* the machine is switched on. VIBXPERT records the current RPM and automatically begins with measurement as soon as the selected start RPM is exceeded. Measurement is stopped when the stop RPM is reached.

Coastdown

Measurement is started *while* the machine is running at the operating RPM. VIBXPERT then begins to measure the RPM continuously. Once you have switched the machine off and it drops below the selected start RPM, VIBXPERT automatically starts recording the data. Measurement stops once the selected stop RPM is reached. Start and stop RPMs are defined in the measurement setup (see p. 3-10).

A. Selecting the measurement task

The measurement tasks for a runup / coastdown curve are located in the 'Advanced' tab.

A.1 Selecting the measurement task via the measurement task icon:

- Highlight the respective icon.
- Press the MENU key and click on 'Task Manager'.
- Click in the uppermost menu to display the stored measurement tasks. The 'Show Dual Tasks' or 'Show Single Tasks' menu entries display the available 2-channel or 1-channel tasks (see below)
- Select the required measurement task.

Runup / Coastdown
Phase



Runup / Coastdown
Overall values (RPM)

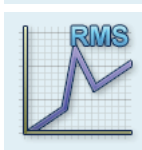

Left:
Selecting the
measurement task

Right:
Starting the measurement
Overall value - RPM

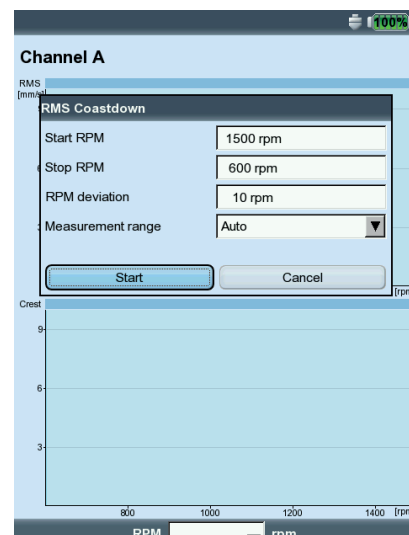
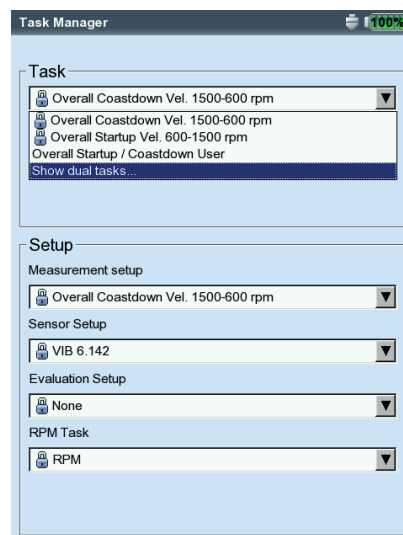

A.2 Selecting the measurement task in the Task Manager:

- Highlight the respective icon.
- Press the F key to display the stored measurement tasks
- Select the required measurement task using the identifier.
- DUAL or 2-C: 2-channel measurements
- OVERALL VALUE: 'Overall Value - RPM' measurement type
- STARTUP: Runup
- COASTDOWN: Coastdown

F

B. Starting the measurement

- Click on the measurement task icon.

A connected laser-trigger sensor is automatically switched on for adjustment.

Do not look into the laser beam! Risk of eye damage!



A dialog window appears in the measurement screen in which you can temporarily change the following setup parameters:

- START RPM, STOP RPM
- RPM DEVIATION
- MEASUREMENT RANGE.
- Click on 'Start' to start the measurement.

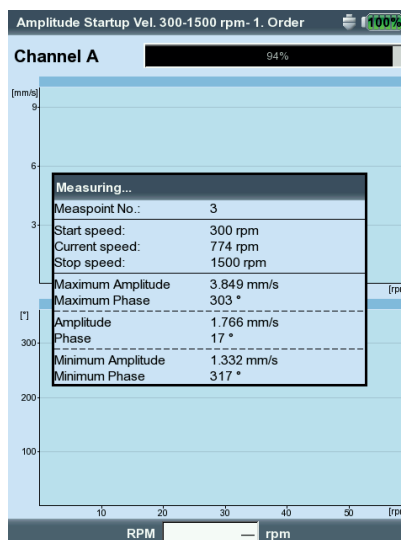
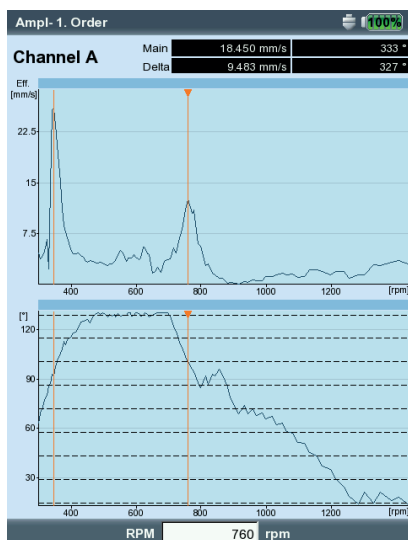

Left:
Runup / Coastdown
Phase - RPM (Bode plot)

Right:
Results screen during a coastdown measurement
Phase - RPM

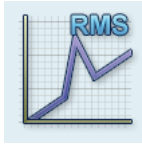

C. Supplementary information

C.1 'Overall Value - RPM' measurement type

This type of measurement records the progression of the characteristic overall vibration values relative to the RPM. Points of resonance are indicated by RPMs with increased vibration amplitudes.

The Results screen displays the path of the RMS value in the upper diagram; one of the three peak values (0-p, p-p, crest factor) can be displayed in the lower diagram:



- To do this, press the F key and select the respective characteristic value (see below).



C.2 'Phase - RPM' measurement type

This type of measurement records the phase amplitude and the phase angle in dependence on the RPM. Points of resonance are indicated by RPMs with increased amplitude and a simultaneous jump in phase angle by (ideally) 180°. The results are displayed either in a Bode diagram or in a Nyquist diagram.

Bode diagram

The upper curve shows the amplitude progression and the phase is displayed in the lower screen. The Zoom function applies to both diagrams.



Note

If the 'Continuous Phase' option in the display setup is enabled, a number of dotted horizontal lines may appear in the phase diagram under certain circumstances. These lines represent the '360° - 0°' transition that can occur any number of times due to the constant continuation of the phase progression (see P 3-29)

Runup / Coastdown

Left:
Overall value - RPM
selecting peak value

Right:
Phase - RPM (Bode diagram)

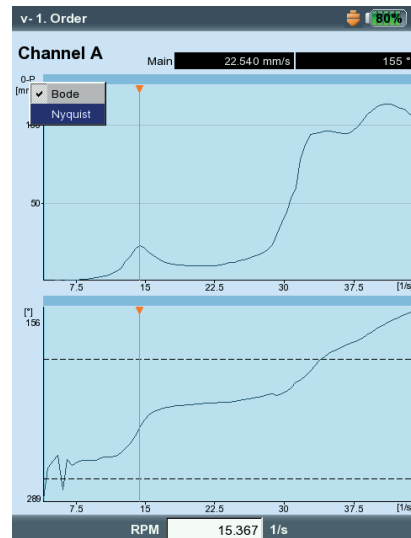
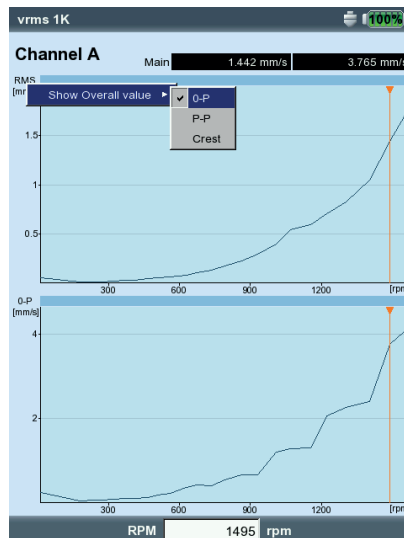

Nyquist diagram

This type of diagram displays the locus (amplitude and phase) of the curve in polar coordinates (see below right).

Changing the type of diagram

Press the F key and select the type of diagram.

F

Averaging cancellation if rpm deviation > 10%

VIBXPRT records a time signal block per shaft rotation and combines multiple blocks to an average signal, depending on the averaging number. If the rotational speed varies by more than 10% during averaging, VIBXPRT aborts the averaging and uses the averaged signal to calculate the amplitude and the phase angle. These values are only saved if the rpm deviation set in the measurement setup is reached.

C.3 Two-channel measurement

In two-channel measurements, it is possible to display the channels individually or together in one screen. Press the F key and select the option 'Display Channel -> A , B or A+B'.

F

'Channel A+B' display:

Channel A is shown in blue, channel B is shown in green.

The delta cursor is not available for 2-channel measurements.

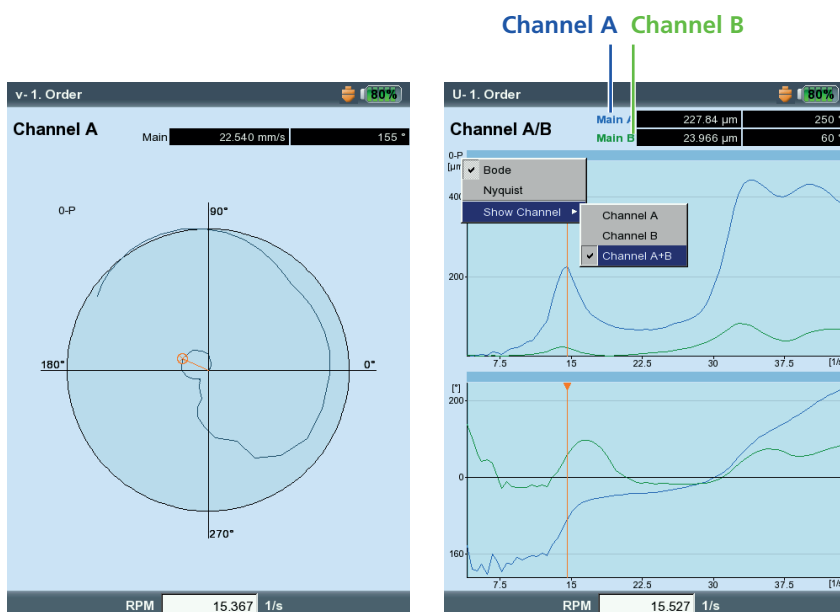

Note

**Runup / Coastdown**

Left:
Phase - RPM (Nyquist diagram)

Right:
Select 'Channel A + B'

C.4 Measuring rate (number of measurement points)

An important criteria for the quality of the results is the number of measurement values saved. The more measurement values, the more meaningful the measurement. The decisive factor here is how quickly the machine reaches the operating RPM or how quickly it comes to a standstill. The greater the time required for this, the more measurement values VIBXPRT can record. If the time period is too short for a sufficient number of measurement values, the 'Overlap' parameter can be increased in the measurement setup in order to increase the measurement rate (see below and P 3-9).

In machines the coast up and down very slowly, the number of saved measurement values can be very high without significantly improving the quality of the results. In this case, you can reduce the measuring rate - i.e. the number of saved measurement values per change in RPM - and save memory space at the same time. In the measurement setup, set the 'RPM deviation' parameter to a higher value - either in the measurement setup or immediately before beginning the measurement (see p. 3-38). In the example below, a measurement is saved whenever the RPM (rotational frequency*) changes by 1 Hz.

* 1Hz = 60 rpm.



Note

The 'RPM deviation' parameter in the measurement setups set at the factory can also be changed.

To display the number of measurement values saved, press the MENU key in the result screen and click on 'Result Details' (see below).

Left:
Runup / Coastdown - meas. setup
Setup parameters 'overlap',
RPM deviation

Right:
Number of saved meas. values
in the 'Result details' screen

Measurement setup	
Spectrum Coastdown Vel. 1500-300 rpm user	
Meas. quantity	Velocity
Δf	1.0000 Hz
Lower frequency	2.00 Hz
Upper frequency	800.00 Hz
Number of lines	800
Window type	Hanning
Overlap	60.0 %
Measurement range	Auto
Start RPM	1500 rpm
Stop RPM	300 rpm
RPM deviation	10 rpm

Details	Values
Job	Spectrum coast down
Additional info	Number of measurement points: 7
Channel	A
Used range	14.019 m/s ²
Sensor type	LineDrive
Date/Time	08.12.2009 14:12:54
Status	OK
Channel	B
Used range	unknown
Sensor type	LineDrive
Date/Time	08.12.2009 14:12:54
Status	OK

Envelope analysis

Envelope analysis is a proven method for detecting periodic impacts in the vibration signal of a machine. It is mainly used for the diagnosis of roller bearing damage and gearing damage and is based on the demodulation of amplitude modulated vibration signals.

Periodic impact sequences in a component excite high frequency machine resonances that serve as a carrier signal of the low frequency impact signal. To separate the low frequency modulation from the high frequency resonance, the signal is filtered with a high pass filter, rectified and then filtered using a low pass filter. Consequently, the remaining signal consists of the modulation signal only - the so-called 'envelope' - from which the FFT of the envelope frequency spectrum can be calculated.



VIBXPRT saves the envelope time signal filtered last together with the envelope frequency spectrum.

To display the time signal, press the MENU key and select 'Info / Time waveform' (see below).



Note

User-defined measurement quantities

With measurement tasks where the measurement quantity can be freely defined, the input signal ($\pm 30V$, $\pm 30mA$, each AC) can be recorded as a characteristic overall value, time waveform* or spectrum. The assignment of the input signal to the measurement quantity is specified by the 'Measurement quantity' and 'Unit' parameters in the transducer setup (see P. 3-12).



Overall

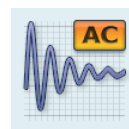

Time waveform

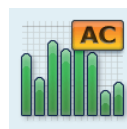

Spectrum

Only the following cables can be used as sensor cables:

VIB 5.433 - Connection cable for low voltage signals

VIB 5.434 - Connection cable for low current signals



Attention!

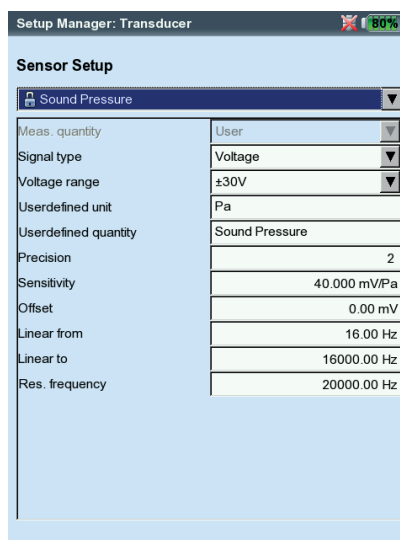
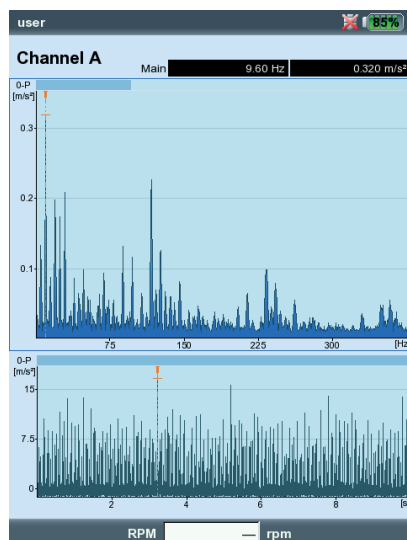

Left:
Envelope spectrum and
appropriate time waveform

Right:
Sensor parameters for
sound pressure measurement

Synchronous Phase

1 channel
'Overall values' tab



2 channels
'Advanced' tab

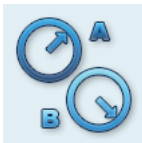

Phase measurement

The phase measurement is used to identify machine faults that cause lines at the same position in the spectrum (e.g. static/ dynamic unbalance). The *synchronous phase measurement* determines the amplitude and the phase angle of the vibration pointer from the RPM-synchronous components of the vibration signal. The reference transducer in this case is a trigger sensor (see p. 3-37). To simplify the diagnosis, the measured signal is processed in an order filter. For example, an unbalance causes severe vibrations in the first order whereas alignment faults dominate in the second order.

Synchronous phase measurement can be performed in one or in two planes. With two channel measurements the phase difference in both planes can be determined. This indicates whether, e. g. static, dynamic or coupled unbalance is present.

Phase trend

If you would like to record the phase trend as a function of time or rpm, save the individual measurements by 'Appending' to a file (see also p. 3-15). In the Display Setup for the trend display (p. 3-29), select either 'Time' or 'rpm' ('Phase over...' parameter). The rpm value and the date of each measurement appear in the lower display field.

To open an individual measurement result in the trend display, press the F key, and click on 'Details' (see below).

Order filter

After the measurement, the order filter can be changed with the +/- key

Alternative:

- Press the MENU key in the results screen.
- Select 'Order', press the right navigation key and click on the required order.

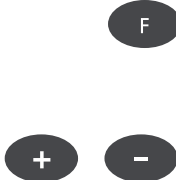

Left:
Synchronous phase measurement

Right:
RPM-based phase trend

A: Result for channel A

B: Result for channel B

Max. display range

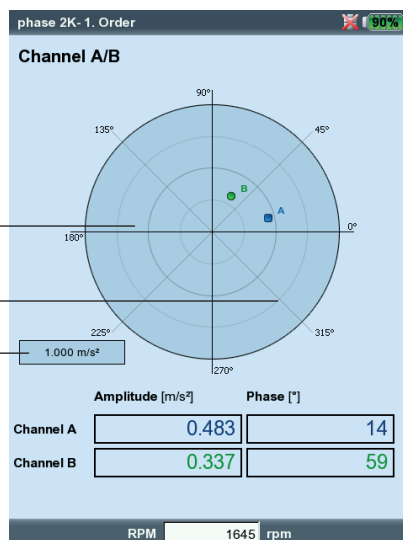

Impact test - 1 channel

The Impact test is used to determine the resonance frequency of a structure. In the case of a rotating machine, it is possible to determine the RPM ranges in which vibrations are disproportionately amplified by resonance* and could damage the machine. These ranges must then be avoided during operation and should be passed through as quickly as possible during runup and coastdown of the machine.



Impact test

Almost any source of vibration that contains as many frequencies as possible is suitable for exciting a structure - such as a pulse-blow with a rubber hammer.

- Check and change the measurement parameters, if necessary.
The measurement can take place with the machine running or at a standstill. The signals from a running machine can be filtered out using the so-called 'negative averaging method'.
- Attach the transducer to the machine - either with a magnet or, even better, with a screw fitting.
- Set the number of individual measurements in the measurement setup (e.g. 2 measurements, see below).
- Start the measurement by clicking on the task icon (see above).
- When the message 'Wait for trigger' appears, excite the machine with a suitable rubber hammer: Strike near to and in the direction of the transducer once per measurement.
- For each single measurement, strike exactly the same location once with the hammer.

After each single measurement, the result can be accepted or discarded (see below). After all measurements have been completed, the averaged final result appears together with the 10 highest amplitudes in the spectrum.

* e.g. excited by an imbalance or mis-alignment

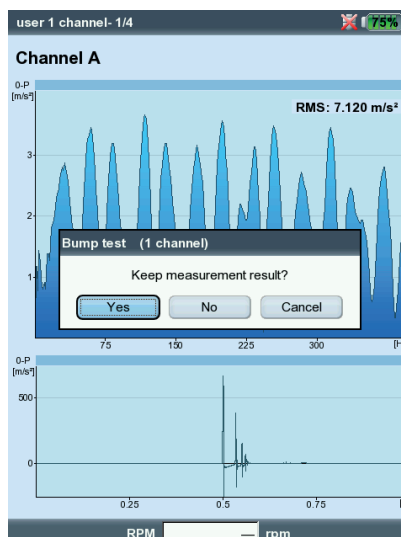
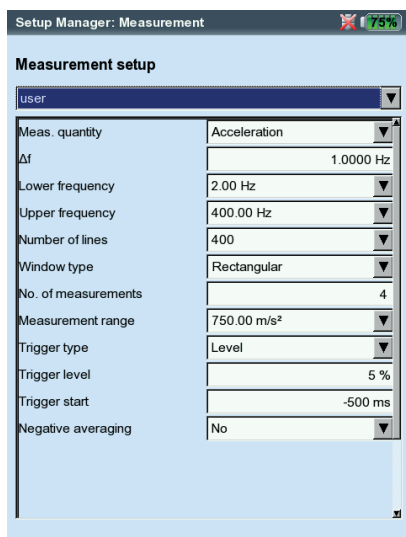

Left:

Setup parameters for impact test

Trigger Start < 0 : Signal is also recorded before the excitation

Right:

Measurement after hammer strike

Spectrum with resonant frequencies and measured time signal

**Note****Tips for setting the measurement parameters**

Set the 'Trigger Start' time to a negative value in order to record the signal before the excitation.

If the measurement starts before the excitation, increase the trigger threshold in the measurement setup by approximately half (P 3-10).

If the response signal overloads, increase the 'Measurement Range' parameter in the measurement setup accordingly.

Measurement with the machine running

- Enable 'Negative averaging' in the measurement setup.
- Perform the individual impact tests.
- Click on 'Start' in the window that opens to measure the reference spectrum - without producing a machine excitation!
- Click on 'Stop' when a sufficient number of reference spectra have been recorded and averaged to form a result (see below).

Displaying the results

- Activate the upper pane with the F key (Spectrum, P 3-20).
- Press the MENU key and click on 'Choose Dataset'.
The results of the impact test, the average final result and the reference measurement (negative averaging) are listed here and can be displayed individually by clicking (see below).
- To close the list, press on the ESC key.

Repeating individual measurements

- Activate the upper pane using the F key.
- Press the MENU key and click on 'Remeasure'.
- Click on the respective measurement in the list.

Left:
Reference measurement
is required when measuring on a running machine

Right:
Dataset selection
Single measurements /
Averaged final result

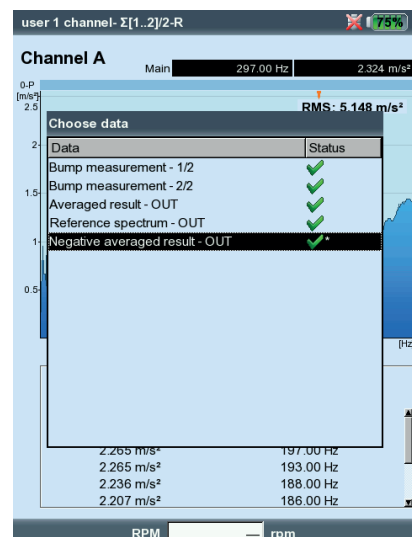
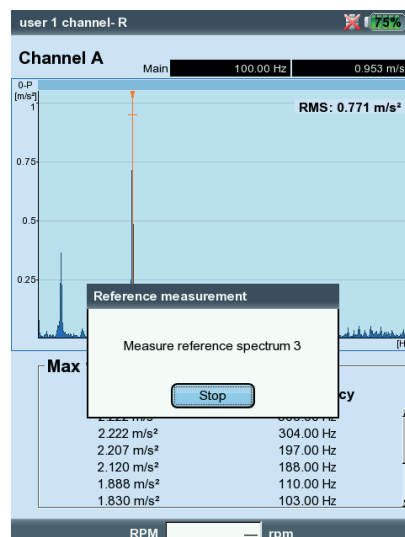

Chapter 4: Balancing

Increased vibrations on machines are undesirable phenomena. They impair product quality, place additional strain on components and, last but not least, reduce operational safety. The most frequent cause for these increased vibrations is imbalance. The high centrifugal forces that result lead to premature wear of machine components such as bearings and seals, for example. Thus, the objective of balancing rotors is to limit bearing forces and shaft deformations to acceptable values.

VIBXPERT enables imbalance to be reliably detected and quickly corrected. The balancing results are automatically compared with the evaluation yardsticks of DIN ISO 1940 for the balancing condition of rotating rigid bodies.

Imbalance

If a rotor is correctly balanced and this rotor is placed on balancing rollers, any additional mass placed on the rotor will cause this mass to immediately move downwards. This process is called 'roll off'. If this rotor is now turned with the balancing RPM, a centrifugal force is caused perpendicular to the rotational axis by the displacement of the center of gravity.

A static imbalance has to be corrected using 1-plane balancing because the planes of imbalance and center of gravity coincide. Considered from the measurement plane, the imbalance is static at a single location.

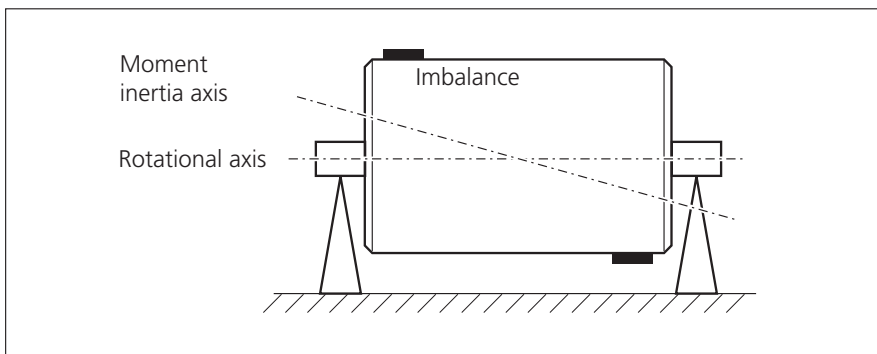

Couple (dynamic) imbalance

If two equally heavy masses are attached to a completely balanced rotor so that they lie exactly opposite in two separately lying radial planes, this is called a couple imbalance (or a dynamic imbalance). The center of gravity of the rotor remains on the rotational axis. The imbalances cause a centrifugal torque that gives rise to opposing forces of the same size in the bearings. Such imbalances can only be balanced using two-plane "dynamic" balancing - one-plane balancing would not bring any improvement.

If an individual imbalance which does not lie on the center of gravity is added to a completely balanced rotor in one plane, it is called a quasi static imbalance. It corresponds to the combination of a static imbalance and a couple imbalance and is usually compensated in two planes.

Basically, the consideration of whether to carry out balancing in one or two planes depends on the specific machine situation, i.e. on the balancing behavior of the rotor and the vibration behavior of the machine. Simultaneous balancing in two planes is quicker and more precise than successive balancing measurements in each of two individual planes. Residual errors that are accumulated in sequential balancing are therefore prevented. The distance/diameter ratio of the balancing planes is normally an important decision criterion.

Two-plane balancing under operating conditions using an optical trigger and two vibration transducers.

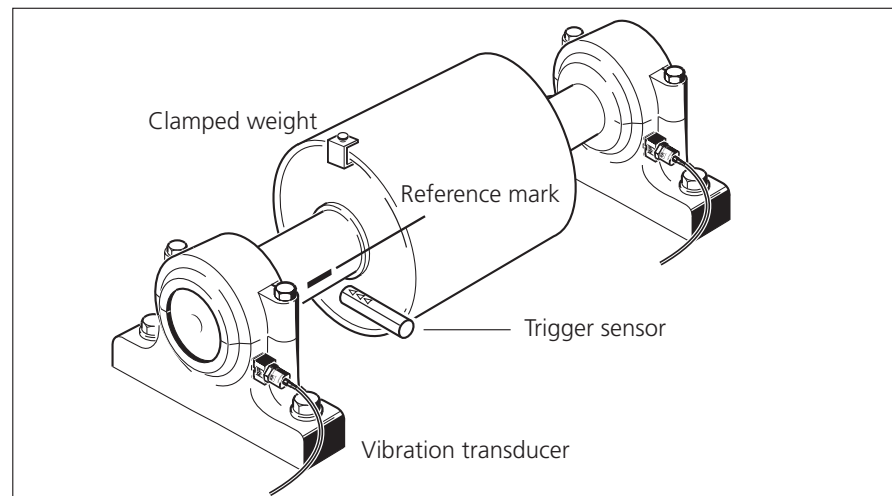

Balancing on machines with rotating masses

The VIBXPERT balancing module is based on the well-known 'influence coefficients method':

First, VIBXPERT measures the vibration amplitude and phase angle and the vibration caused by the imbalance or so-called 'initial imbalance'. A defined trial weight* is then attached and the instrument measures the resulting change in amplitude and phase. VIBXPERT calculates the influence coefficients from the difference between both vibrations according to magnitude and phase which precisely indicates the location and magnitude of the balancing weight with regard to the position and size of the trial weight. In the case of two-plane balancing, the calculation of the influence of the mass is also taken into account in the other plane. All so-called 'rigid' rotors are balanced using this method.

A rigid rotor mainly exhibits proportional vibration behavior if the balancing weight and angle change. In the case of fixed rotational speed, weaknesses or resonances in the mounting have no influence on the vibration behavior. If the machine rotates at a variable speed, it frequently exhibits different vibration behavior for each revolution and, therefore, has to be balanced several times over the range of low-speed to high-speed running.

Soft rotors do not exhibit the expected proportional behavior with the calculated balancing weight, and the coefficients method does not apply. Such rotors can normally only be balanced in balancing machines using a force measuring procedure.

Preparatory activities

Preparations include the mounting of the measurement components.

The machine must be...
 ... disconnected before carrying out any work on the machine.
 ... protected against being switched on again inadvertently!



WARNING!

Assembly

1. Find out the cause of the imbalance visually and fix it if possible, e.g.: Remove any coatings from the impeller, fasten any loose balancing weights or tighten any loose screws on the foundation.

If the machine cannot be balanced in-situ, it must be firmly mounted on a rigid foundation (directly on frames or on vibration isolators).



Note

2. Determine the measurement and balancing planes (see figure on next page). Mount the vibration transducer on the bearing housing at the measurement location with the highest vibration values. Note that:

- The measurement plane should be in the middle of the bearing and close to the balancing plane and the plane of the center of gravity (e.g. impeller side, rotor).
- Vibrations are transferred via the outer ring of a bearing in a radial direction. Thus, mount the transducer on the side (horizontal) or on the top of the bearing (vertical).
- The transducer should be attached as close as possible to the bearing. Prevent signal attenuation due to excessively long transmission paths or bearing covers. The direction of measurement must correspond to the main direction of vibration (mostly horizontal). If the measurement direction is horizontal, mount the transducer on the lower half of the bearing housing.
- Wherever possible, use transducers which are screwed onto the machine or attach the transducer using a magnetic adapter (VIB 3.420). The transducer should not be attached to components with intrinsic vibrations, e.g. covers.
- Hand-held probes are not suitable for balancing!
- Only for balancing in two planes: Determine the second plane (B) in the same way.

3. Assess the machine smoothness.

- Measure the vibration velocity and record an FFT spectrum if the measurement values are too high (see DIN ISO 10816-3). If high vibration signals appear at the rotational frequency, there is an imbalance that must be corrected by balancing.
- Save the measured values in order to be able to compare them later with the values measured after the balancing procedure.

4. Attach a reference mark on the shaft for the trigger sensor while the machine is at a standstill (s. page 3-36).
5. Mount the laser trigger sensor (VIB 6.631) with the trigger bracket (VIB 6.632) on the machine (s. page 3-36).
6. Connect the vibration transducer to the measurement instrument.



Note

- The balancing RPM should lie as close as possible to the operating RPM. If this is not possible due to high vibration values, start at a lower RPM and approach the operating RPM step-by-step in several balancing runs. Minimum balancing RPM: 30 cpm. (= 0,5 Hz).
- Pay attention to potential resonance points and, if there is any doubt, perform a coast down measurement!
- The RPM must remain constant during a balancing run! Otherwise, the balancing run must be restarted.
- The rotor must reach operating temperature during the measurement (e.g. if the rotor works in a hot air stream).
- Often the static imbalance is dominant at vibration values above 10 mm/s. First, compensate this using 1-plane balancing before proceeding with 2-plane balancing.
- Before starting the initial balancing run, check again that all measurement components have been correctly installed.
- If a machine setup is used for the balancing procedure, check the specified parameters. Incorrect rotor data may result in the calculation of excessive trial weights under certain circumstances!

Typical assembly:

Measurement and balancing plane A & B, reference marks, fixing angle ϕ

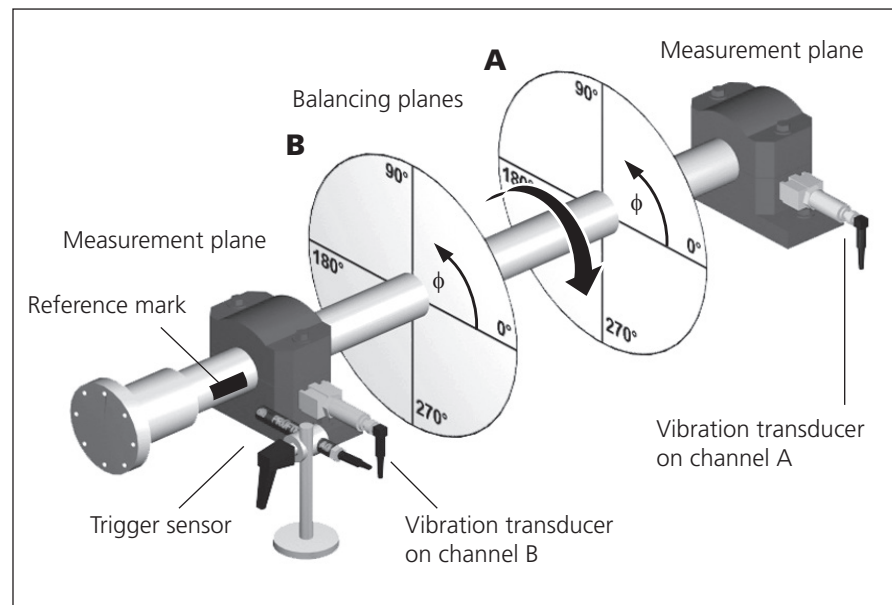

Operation

If you are not yet familiar with operation in balancing mode, please note the following instructions:

Settings

All settings necessary for the measurement and evaluation of a balancing run are made in setup menus. The following setups can only be changed before a balancing run is begun:

- Measurement setup: measurement settings (see p. 4-22)
- Transducer setup: parameters of the transducer in use
- Machine setup: data on rotor and balancing-related settings (see p. 4-25f.)

The settings in the following two setup menus can also be changed during a balancing run:

- Display setup: display settings (see p. 4-20).
- Tools: balancing-related settings and parameters that can be changed during a balancing run (see p. 4-15f.).

Display

In each balancing run, two main screens appear:

Data screen

The upper half of the screen shows the balancing weights and their positions on the rotor. The lower half contains the measurement data and balancing weights of all completed runs. If a machine setup is used, it shows the balancing quality attained and the resulting centrifugal force on the rotor.

Measurement screen

The measurement values (amplitude and phase angle) are displayed and the imbalance pointer is shown in a polar diagram.

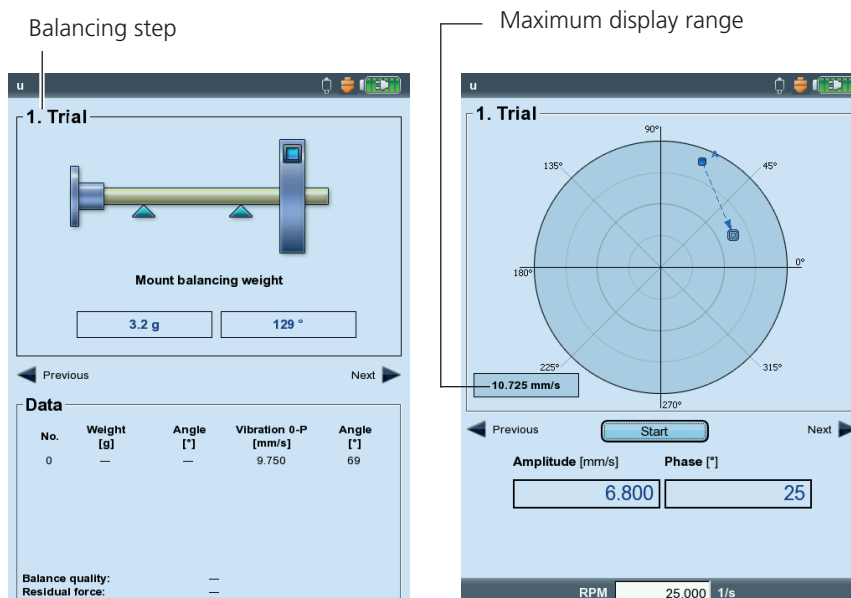

Left:
Data screen

Right:
Measurement screen

Balancing: Operation

The respective balancing step appears on the upper left of both screens:

0. Initial imbalance

Measurement of the original imbalance; if the vibration values are within the tolerance range, the rotor is balanced. Otherwise, the balancing weights must be placed on the rotor according to the following balancing steps.

1st trial run

The influence of the attached trial weights is measured and the resulting balancing weight is calculated.

2. Trim to ..N. Trim

Trim runs for reduction of rotor imbalance.

The initial imbalance pointer represents the starting point of the balancing procedure. The arrow direction indicates the path of the balancing runs. A dashed pointer marks a balancing run in which the weight was removed (see figure below).

Zoom

VIBXPRT automatically scales the display range with respect to the last two balancing runs. To magnify the view, press the "+" button repeatedly. If the initial imbalance moves out of the display range, the maximum range is also given as a percentage of the initial imbalance.

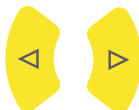

Navigation

To scroll forwards and backwards, press the right or the left navigation key respectively.

Starting / stopping the measurement

Press the Enter key in the measurement screen.

Left:
Zooming the measurement screen

Right:
Balancing runs in the measurement screen

Starting/stopping the measurement:
<Start> / <Pause>

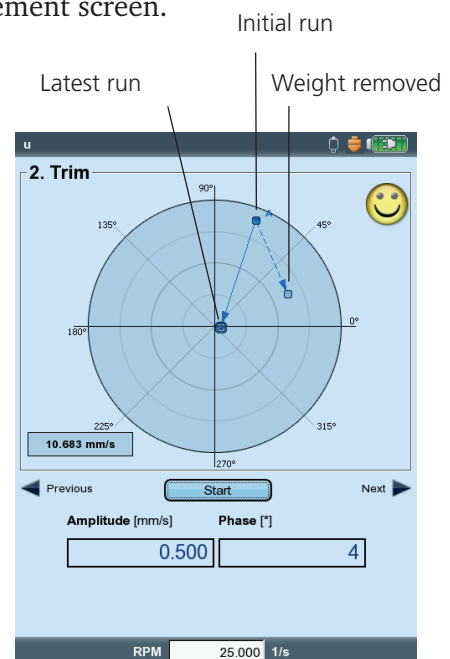
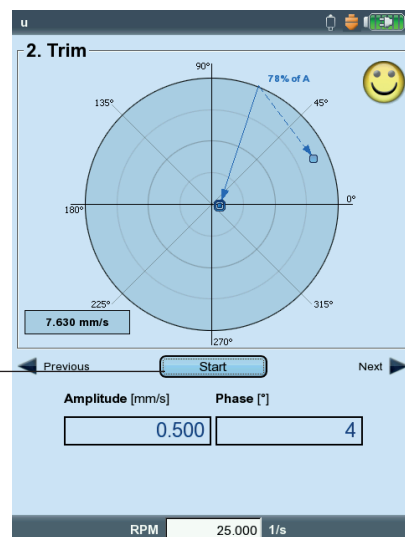

Balancing in one plane

On the basis of an example, the next section illustrates the steps that are needed to balance in one plane:

Requirements

- In the following example, the machine setup is not used.
- The default settings in the 'Tools' menu item are not changed:
 - Correction mode: free
 - "Add" balancing weights
 - Check that the functions are all active, except for the coefficients calculation which is inactive.
 - 'Use different radii' option: inactive

Activating the balancing mode

1. Switch on VIBXPRT.
2. Click on the "Balancing" icon in the start screen.



Selecting the task

1. Open the '1-plane' tab.
2. Highlight the rotor graphic which corresponds to the rotor type.
3. Optional: Check and change the current measurement task beforehand if necessary. (MENU - Task Manager - Setup)
4. Click on the rotor graphic to open the measurement screen



Adjusting the trigger sensor

1. Connect the trigger sensor to VIBXPRT (see p. 3-36).
2. Press MENU, and click on "Power up keyphasor".
3. Adjust the trigger sensor to the reference mark on the shaft.

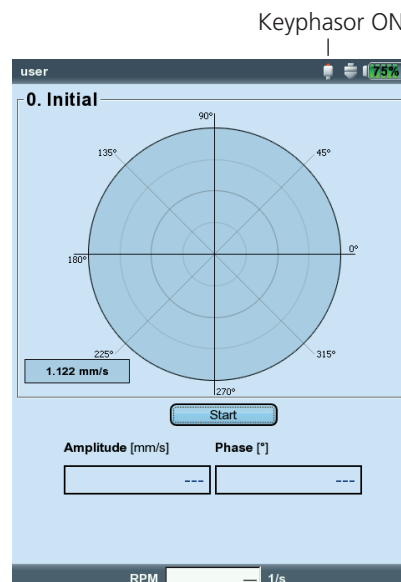
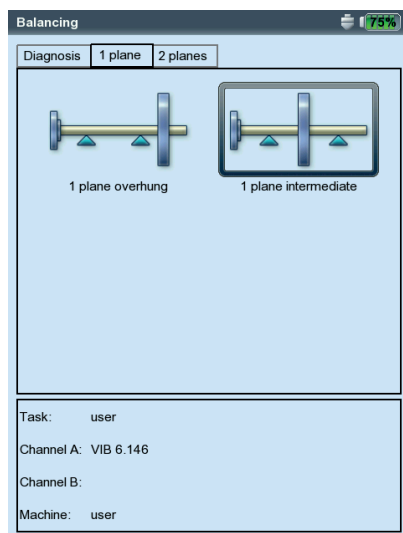

Left:
Selection screen

Right:
Start 'Initial' run

Balancing: 1-plane balancing

Measuring the initial imbalance

1. Switch the machine on. Wait until the machine has reached the balancing RPM and operating temperature if necessary.
2. Press 'Enter' to start the measurement.

Enter

First, VIBXPRT records the RPM. The green LED flashes with each trigger pulse. If the RPM varies too much, a warning message appears.

Finally, the instrument measures the amplitude and phase of the RPM synchronous vibration. If the values are unstable, the average is automatically increased.

Enter

3. If the measurement values are stable, press 'Enter' to stop the measurement (see previous page).
To repeat the measurement, press 'Enter' again.
4. Switch the machine off.

Trial run

1. Press the right navigation key to open the data screen for the trial run.
2. Enter the mass and fixing angle for the trial weight.
Click on the mass or angle field under the rotor graphic, and enter the respective value in the number editor.



If the trial mass is applied at random, there is a risk of increased imbalance and thus an increased vibration load. Especially if vibration loads are already very high, this may result in further machine damage.



3. Press the right navigation key until the next screen appears.

Left:
Measure 'Initial' run

Right:
Enter mass and angle for trial run

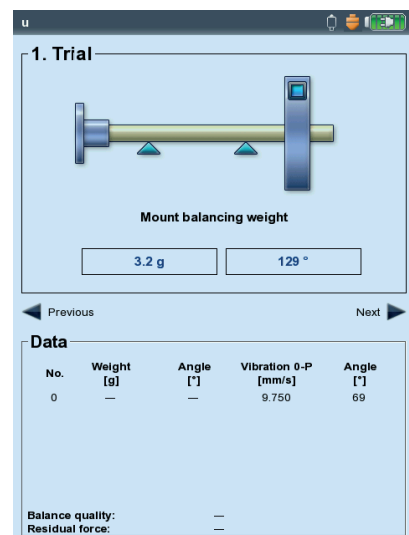
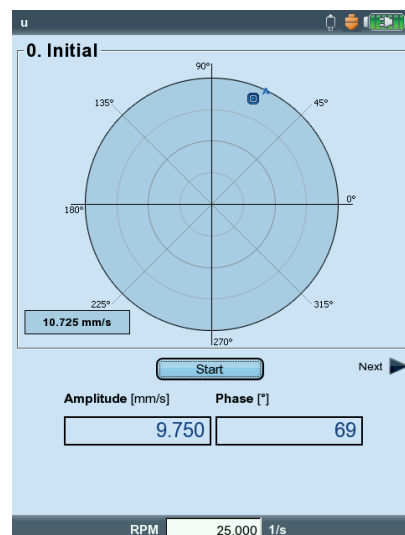

4. Switch the machine on.
5. Press 'Enter' to start the measurement.
6. If the measurement values are stable, press 'Enter' to stop the measurement.
7. Switch the machine off.



In the trial run the imbalance should change enough to steadily reduce the residual imbalance in the subsequent balancing runs. If the imbalance changes only slightly, increase the trial weight. If the imbalance has more than doubled, use a smaller trial weight (see the 'Tools' parameter, 'Check bad influence', p. 4-17). If necessary, scroll back in the data screen of the trial run, change the mass accordingly and repeat the trial run.

Trim run

1. Press the right navigation key to close the measurement screen of the trial run and to open the data screen of the first trim run.
Depending on whether the trial weight resulted in an improvement or not, it can be left on the rotor or taken off. Respond to the resulting prompt in the screen accordingly.
2. Attach the recommended mass at the specified position on the rotor. If necessary, also change the values.
3. Press the right navigation key until the next measurement screen appears.
4. Switch the machine on.
5. Press 'Enter' to start the measurement.
6. If the measurement values are stable, press 'Enter' to stop the measurement.
7. Switch the machine off.

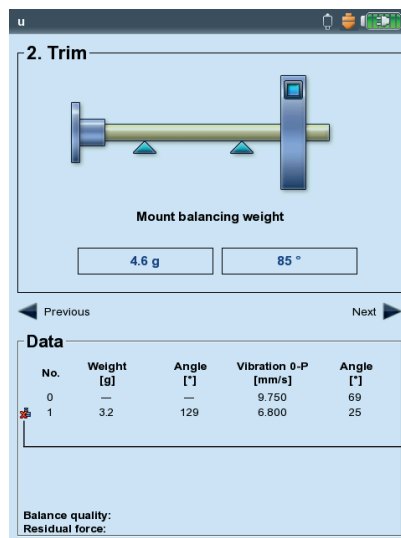
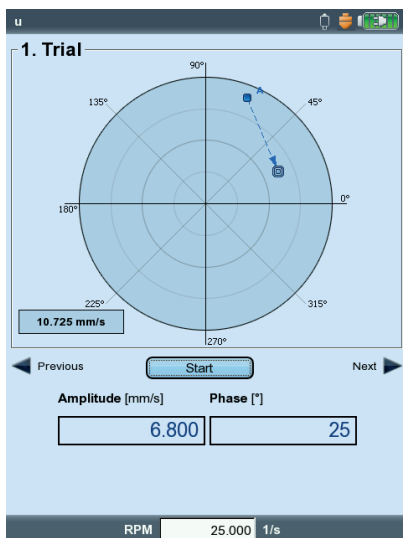

Left: Measure trial run

Right: Trim run data screen

= Trial weight was removed

In the following trim runs VIBXPRT checks whether the imbalance has sufficiently reduced from one run to the next. If this is not the case, the following message appears: 'No Improvement'. The run concerned must be repeated with a different balancing weight.



Note

Start again if the vibration values worsen and the balancing weights do not become smaller.



8. Press the right navigation key and continue the balancing with the next trim run.



The balancing procedure is complete as soon as the vibration values have reached an acceptable value. When working with "Machine Setup", the calculated balancing quality is the criterion for terminating the balancing procedure. A 'smiley' appears in the measurement screen if the balancing quality has reached the tolerance range.

Undoing balancing runs

If the measurement results worsen after a trim run, you can return to a run that was acceptable and continue balancing with different weights from there.

- Navigate to the data screen of the trim run at which you wish to continue the procedure.
- Press the MENU button and click on 'Undo' (see below).
- Confirm the next query with 'Yes!'. All subsequent trim runs are deleted.
- Remove the balancing weights that you attached during the deleted trim runs.

Left:
Balancing quality achieved
(balancing with machine setup)

Right:
Undoing balancing runs

3. Trim

Mount balancing weight

0.2 g 20 °

No.	Weight [g]	Angle [°]	Vibration 0-P [mm/s]	Angle [°]
0	—	—	9.750	69
1	3.2	129	6.800	25
2	4.6	85	0.500	4

Balance quality: 0.153 @ 11.000 1/s
Residual force: 0.437 N @ 11.000 1/s

2. Trim

Mount balancing weight

85 °

No.	Weight [g]	Angle [°]	Vibration 0-P [mm/s]	Angle [°]
0	—	—	9.750	69
1	3.2	129	6.800	25
2	4.6	85	0.500	4
3	0.2	20	2.700	12
4	0.2	20	11.000	11

Balance quality: 0.153 @ 11.000 1/s
Residual force: 8.520 N @ 11.000 1/s

Balancing in two planes

In principle, the process here corresponds to the previous section. Therefore, only the specific features of balancing in two planes are described in the following section:

Overview of the measurement procedure

Select plane A: Determine the measurement and balancing plane A.

0. Initial imbalance: Measurement in plane A and plane B
- 1A. Trial run: Recommendation for trial weight in plane A; measurement in plane A and plane B with trial weight in plane A
- 1B. Trial run: Recommendation for trial weight in plane B; measurement in plane A and plane B with trial weight in plane B
2. Trim run: Recommendation for balancing weight in plane A & B; measurement in plane A and plane B
-
- N. Trim run ...

Determining the measurement plane & balancing plane A

1. Activate the balancing mode.
2. Open the "2 planes" tab.
3. Click on the rotor graphic which corresponds to the rotor type.
4. Select plane A:
 - Connect the transducer which is mounted in measurement plane A to measurement channel A (see "Overview").

Measuring the initial imbalance in plane A and plane B

Switch the machine on and start the initial run.

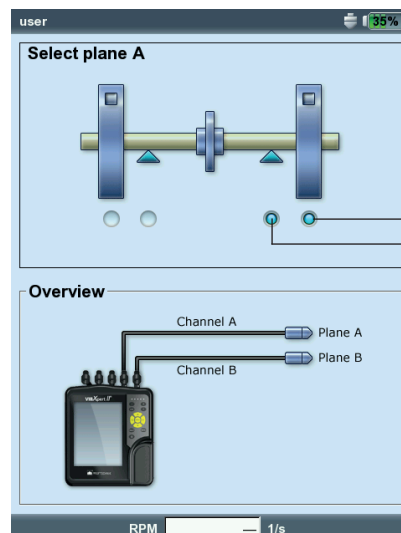
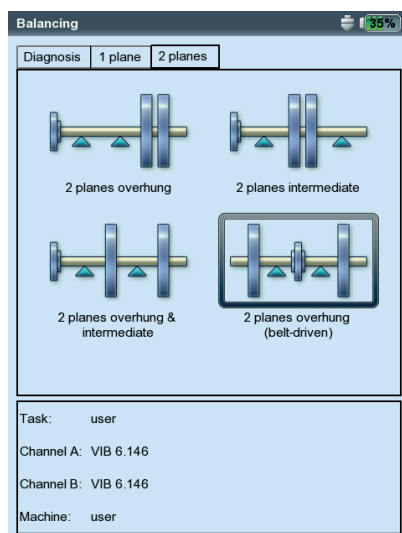

Left:
Selection screen - rotor type

Right:
Setting of plane A

Balancing plane A
Measurement plane A

Balancing: 2-plane balancing

Trial run

The trial run is divided into two parts which are marked in the main screen as "1A" or "1B":

1A: The trial weight is attached in **plane A** and its influence is measured in both planes.

1B: The trial weight is attached in **plane B** and its influence measured in both planes.

Trim run



Enter the balancing weights for both planes in the data screen of the trim run (see next page). Press the right navigation key to mark the input fields of the series.

Continue the trim run until the residual imbalance is within the tolerance range.

Saving the result

1. Press the MENU button in the data screen.
2. Click on 'Save' to open the text editor.
3. Enter a name.
4. Finally press the MENU button and click on 'OK'.

Current balancing plane is marked: blue (A) or green (B)

Left:
Input of trial weight in plane B

Right:
Trial run 1B
Imbalance in planes A and B with trial weight in plane B

1B. Trial

Mount balancing weight in plane B

B

No.	Weight [g]	Angle [°]	Vibration [mm/s]	Angle [°]
0 A	---	---	4.315	19
0 B	---	---	3.222	63
1 AB	2.0	80	29.976	58
1 AB	---	---	7.548	191

Balance quality: ---
Residual force: ---

'AA': Result in **plane A**
'AB': Result in **plane B**
(trial weight always in plane A)

1B. Trial

6.508 mm/s

Amplitude [mm/s] Phase [°]

Channel A

Channel B

RPM 1/s

Evaluation of the data

The following data are listed in the data screen for each completed balancing run:

- MASS: Mass of the balancing weight
- ANGLE: Fixing angle
- VIBRATION: Vibration overall values (RMS, 0-p, p-p*)
- ANGLE: Phase angle

* see Display setup, p. 4-20

If you entered the rotor mass and the balancing radius in the machine setup or the tools menu respectively, then the achieved balancing quality and the centrifugal force on the rotor are also calculated. As a reference RPM, either the measured RPM or the explicitly entered RPM value is used (parameter, Speed (for balance quality), p. 4-24).

If the balancing quality is within the range of tolerance, the "smiley" appears and indicates the end of the balancing procedure.

Data View

- Press the MENU button in the data screen and click on "Data". The "Data View" screen appears.

Here you can combine several balancing weights to a single weight and display the following information:

- MACHINE NAME: Name of the machine setup if used
- DATE & TIME: Date and time of the last balancing run
- SPEED: Current rotational speed
- BALANCE QUALITY: Balance quality relative to reference speed.**
- RESIDUAL UNBALANCE: Imbalance after the last balancing run

** can differ from measured value.

An icon marks the balancing runs in the list where the attached balancing weight was removed again from the rotor after the measurement (e.g. trial run with weight in plane B: ('1BB'), see figure below). The corresponding vector is represented by a dashed line in the polar diagram (see illustration on page 4-6).

 = Balancing weight was removed

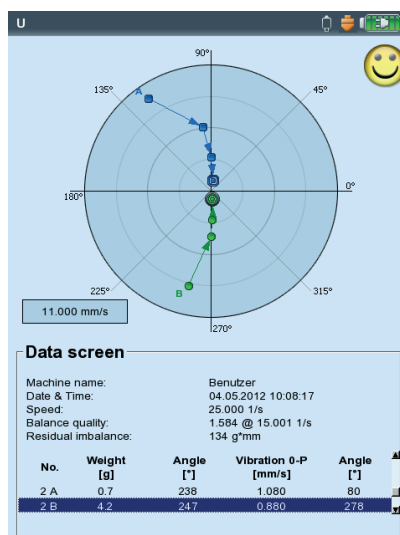
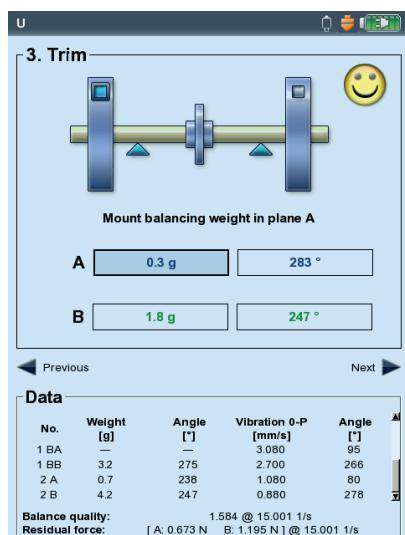

Left:
Data screen
Balancing quality OK

Right:
Data View screen

Options for balancing

1. Combining balancing weights

If several weights have already been placed on the rotor, they can be combined into one single weight. VIBXPERT vectorially adds the weights of the completed balancing runs and displays the resulting weight and fixing angle in the 'Data' screen and the 'Data View' screen.

- Press the MENU button in the Data screen, and click on 'Data'. The Data View screen appears.
- Press the MENU button, and click on "Combine":
The newly calculated balancing weight appears in the list in the line for the next balancing run. All combined runs are marked with a sum symbol ('Σ').
- Then press the MENU button and click on "OK" to accept the combination of the balancing weights.
- Before continuing with the next balancing run, remove the weights that were already attached and attach the newly calculated balancing weight to the rotor.

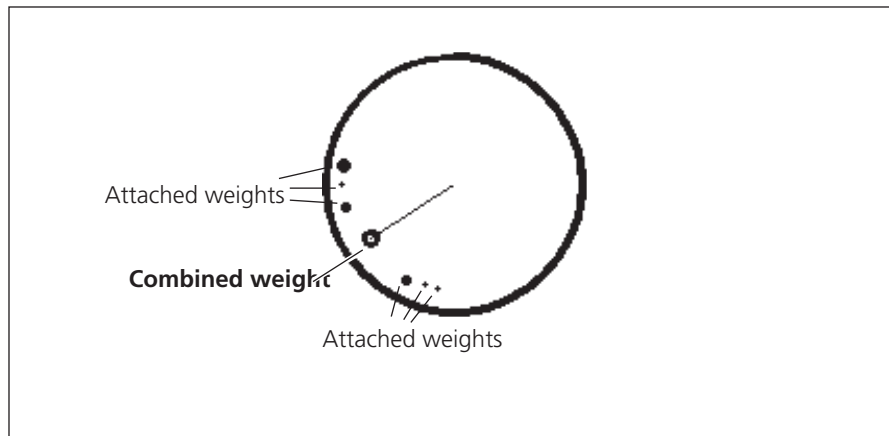

Combined weights

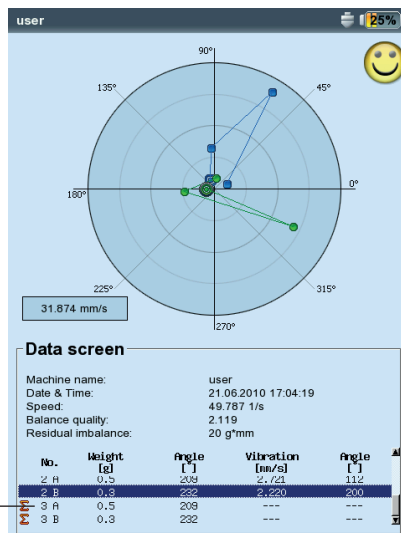

'A': Result in plane A
'B': Result in plane B

The weights from runs '1' to '2' were combined:
Run '3' is carried out with the newly calculated weight .

2. Changing the correction mode (Tools menu / Machine setup)

The correction mode describes how the balancing weight is attached to the rotor. Normally the correction mode is set to 'Free & add', i.e. the weight can have any mass and be placed at any angular position.

- Press the MENU button in the data screen, and click on "Tools" (see below)*.

The following correction modes are available additionally:

- Fixed location
- Fixed weight
- Measuring tape

The following can be selected for each correction mode:

- Add weight on rotor, or
- Remove weight from rotor

For 2-plane balancing the correction mode can be configured separately for each plane.

* Machine setup see page 4-22

2.1 Fixed location

To attach the balancing weight only at specific positions on the rotor (e.g. on the blade of a ventilator), select the "Fixed location" correction mode. Then enter the "Number of locations" on the rotor. VIBXPERT calculates two masses which are to be placed at two of the specified positions. Position or blade 1 corresponds to the 0° position and should be selected as a reference mark for the trigger. In the data screen, the angular position is displayed for each fixed location.

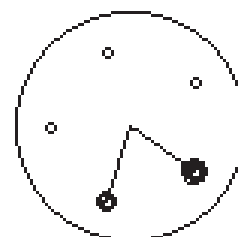

"Fixed location" correction mode

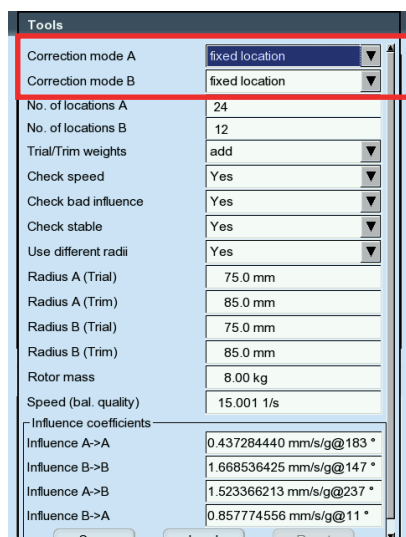
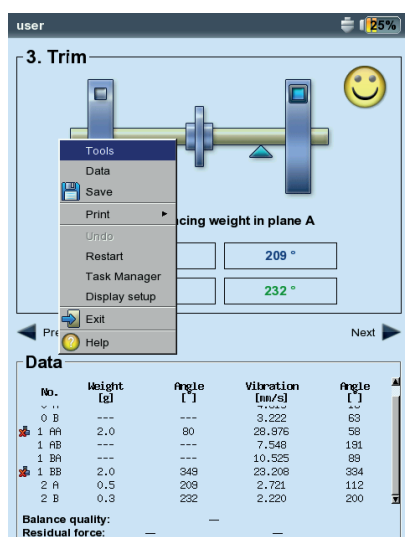

Left:

Changing correction mode in "Tools"

Right:

"Fixed location"

Setting the number of fixed locations

Balancing: Options

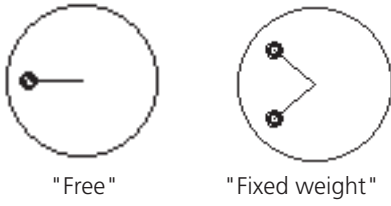

2.2 Fixed weight

Activate the "Fixed weight" option if only specific masses (e.g. 2g, 5g, 10g) are available for balancing. Then enter the mass of the "Fixed weight". VIBXPERT calculates two angular positions at which the two equal weights must be placed.

Select the "Trial/ Trim masses -> Add" option in the "Tools" menu.

The fixed weight m_{fix} must meet the following requirements relative to the variable weight m_{free} :

$$0.5 \times m_{free} \leq m_{fix} \leq 3 \times m_{free}$$

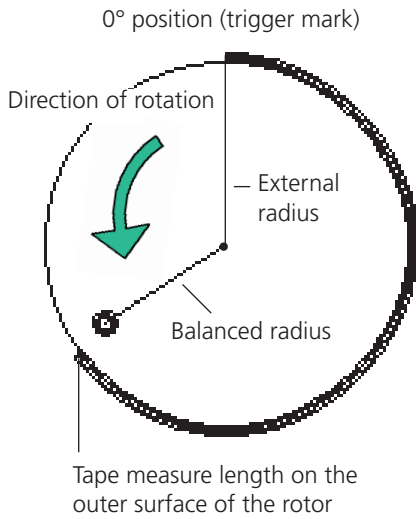

2.3 Measuring tape

The correction mode can determine the position of the balancing weights with the measuring tape without having to consider a reference system with angular divisions.

Enter the outer diameter of the rotor in plane A and plane B. The distance on the outer surface of the rotor is calculated in millimeters (or inches) from the trigger mark (0° position) and measured counter to the direction of rotation. Place a tape measure around the rotor and place the balancing weight at the specified position (i.e. length).

The distance of the balancing weight from the rotational axis is the balancing radius. This is usually smaller than the outer radius.

In all three correction modes, the calculated specified values can be changed afterwards. However, the changes should not deviate significantly from the specified values.

The list in the "Data" field always shows the balancing weights for the 'Free' correction mode - i.e. mass and angular position.

Left: "Fixed weight" correction mode

Right: "Meas. tape" correction mode

No.	Weight [g]	Angle [°]	Vibration [mm/s]	Angle [°]
0 B	---	---	3,222	63
1 AB	2.0	80	28,976	58
1 AB	---	---	7,548	191
1 BH	---	---	10,525	89
1 BB	2.0	349	23,208	334
2 A	0.5	209	2,721	112
2 B	0.3	232	2,220	200

Balance quality: 2.119
Residual force: A: 1.989 N B: 1.424 N

No.	Weight [g]	Angle [°]	Vibration [mm/s]	Angle [°]
0 B	---	---	3,222	63
1 AB	2.0	80	28,976	58
1 AB	---	---	7,548	191
1 BH	---	---	10,525	89
1 BB	2.0	349	23,208	334
2 A	0.5	209	2,721	112
2 B	0.3	232	2,220	200

Balance quality: 2.119
Residual force: A: 1.989 N B: 1.424 N

3. Removing the balancing weight (Tools menu/ Machine setup)

If the balancing weights cannot be attached to the rotor by clamping, welding, screwing or similar, the imbalance can also be compensated by grinding material off the rotor. To do this, select the "Trial/ Trim weights -> remove" option in "Tools" menu (see below). VIBXPRT then calculates the "Balancing weights" with negative sign.

4. Check functions (Tools menu / Machine setup)

In order to ensure that the balancing procedure provides reliable and usable results, VIBXPRT has the following check functions:

- Press the MENU button in the data screen, and click on "Tools" (see below)*.

* Machine setup see page 4-22

CHECK SPEED

During measurement and between the balancing runs VIBXPRT checks whether the RPM is stable. An appropriate error message appears if the RPM varies excessively.

CHECK BAD INFLUENCE

The change of the imbalance indicator is checked between the balancing runs; if the change is too large or too small, an appropriate message appears. Return to the previous balancing run and reduce or increase the weight used.

CHECK STABILITY

The stability of the imbalance indicator is checked during the measurement. If the imbalance indicator is unstable and the 'Auto-average' option is active (s. p. 4-24), VIBXPRT automatically increases the selected number of averages in the measurement setup. An appropriate message appears if the maximum number of averages is reached.

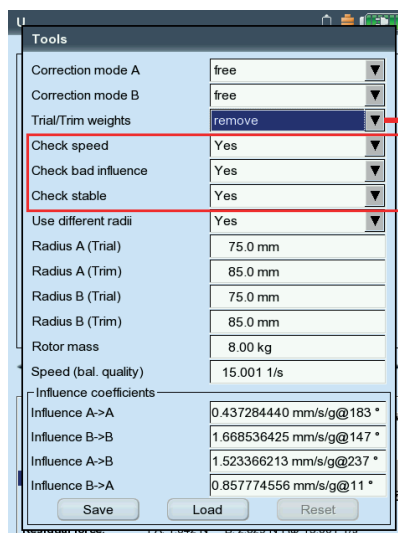

"Remove balancing weight"
Grinding off rotor material

Checking functions

5. Entering the balancing radius and rotor mass later (Tools)

If you start the balancing procedure without the machine setup, you can enter the balancing radius and the rotor mass later in the Tools menu. VIBXPRT then calculates the balancing quality and the centrifugal force for the current trim run.

If you use different balancing radii for the trial run and the trim runs, activate the 'Use different radii' option and enter the appropriate values.

6. Speed for balance quality (Tools menu / Machine setup)

The balance quality and the centrifugal force on the rotor are specified in relation to a reference RPM. In the Tools menu* you can enter a value under 'Speed for balance quality', which is used in all balancing runs. If you set this value to zero (= 'not used'), then the measured RPM is used for the calculation.

* Machine setup see page 4-22

7. Influence coefficient (Tools menu)

After the test run, VIBXPRT calculates the influence coefficient that is used to calculate the balancing weights in the subsequent balancing runs.

If you wish to use the influence coefficient from a previous balancing measurement, you have the following options:

1. Manual entry via the number editor:
 - In the Tools menu, click on 'Influence'.
 - First enter the amplitude.
 - Press the MENU button and click on 'OK'.
 - Enter the angle.

The screenshot shows the 'Tools' menu with the following settings:

Correction mode A	free
Correction mode B	free
Trial/Trim weights	remove
Check speed	Yes
Check bad influence	Yes
Check stable	Yes
Use different radii	Yes
Radius A (Trial)	75.0 mm
Radius A (Trim)	85.0 mm
Radius B (Trial)	75.0 mm
Radius B (Trim)	85.0 mm
Rotor mass	8.00 kg
Speed (bal. quality)	15.001 1/s
Influence coefficients	
Influence A->A	0.437284440 mm/s/g@183 °
Influence B->B	1.668536425 mm/s/g@147 °
Influence A->B	1.523366213 mm/s/g@237 °
Influence B->A	0.857774556 mm/s/g@11 °

Buttons at the bottom: Save, Load, Reset

2. Load the coefficient from the file:

- Click on 'Load'.
- Select the coefficient file.

Here, the coefficient must be saved after the trial run.



Note

3. Adopting the influence coefficient by restarting from a file:

- Open the balancing file.
- Navigate to the last balancing step (measurement or data screen).
- Press the MENU button, and click on 'Restart'.
- A warning appears. Click on 'OK'.
- Start the balancing measurement ('Initial imbalance').

To reset the influence coefficients in a file, click on 'Reset' in the Tools menu. To save the influence coefficients in a file, click on 'Save' in the Tools menu.

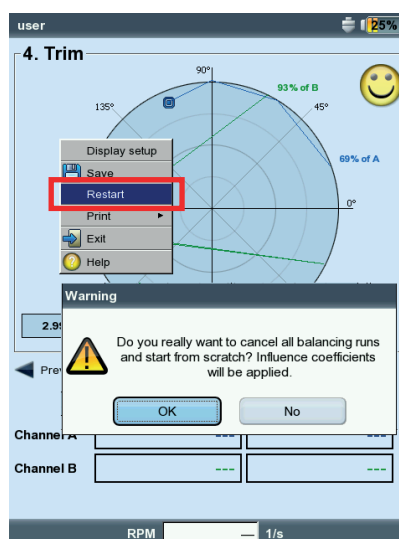

Adopting the influence coefficient by restarting

Display setup

In the display setup, you can define the display settings for the data screen and measurement screen. The display setup can be called up on every screen:

- Press the MENU button and click on 'Display setup'.

ZOOM: Speed or step size when zooming.

DUAL PLANE BALANCING, PLOT MODE: The imbalance pointers of the two planes can be displayed separately in *two polar plots* or together in *one polar plot*.

AMPLITUDE: The vibration amplitude can be specified in RMS, 0-p or p-p.

STEP LIST DETAIL: Select 'detailed' if you would like all balancing runs to appear in the data and measurement screen. The 'short' option only shows the first run (initial imbalance) and the last completed balancing run.

Left:
Opening the display setup
Right:
Parameter in the display setup

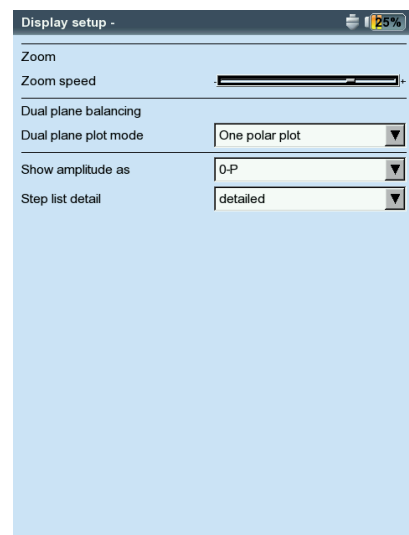
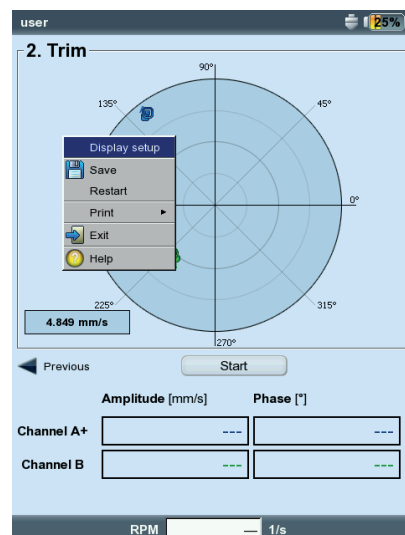

Printing the balancing report

Two different report types are available for documentation:

- *Screenshot*: Printout of the current screen
- *Report printouts*: Detailed report printout with general measurement data and balancing-related data.

A report printout can be started from the measurement or data screen:

Screenshot

- Press the MENU button and click on 'Print > Screenshot'.
- Select the printer, press the MENU button and click on 'Print'.

Report printouts

- Press the MENU button and click on 'Print > Report printouts'.
- Select the printer.
- Select the report configuration in the 'Reports' menu, or create a new report configuration (see page 3-31).

General report information can be entered in the 'Common settings' tab.

The balancing-related report content is found on the 'Measure Info' tab:

POLAR PLOT: The balancing report contains a polar plot showing the completed balancing steps.

STEP LIST DETAIL: The balancing report contains all balancing steps ('detailed') or only the first and last steps ('short').

BALANCE QUALITY / IMPROVEMENT: The balancing report contains the balance quality (setpoint and actual value) if balancing was performed with the machine setup. If a machine setup was not used, the improvement in the vibration values is shown in percent.

- Press the MENU button and click on 'Print'.

Starting a report printout

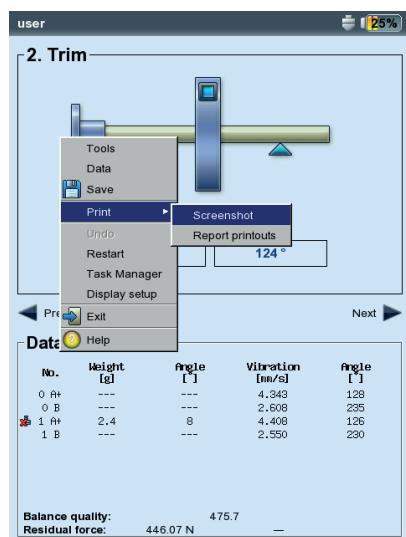

Balancing-related report content

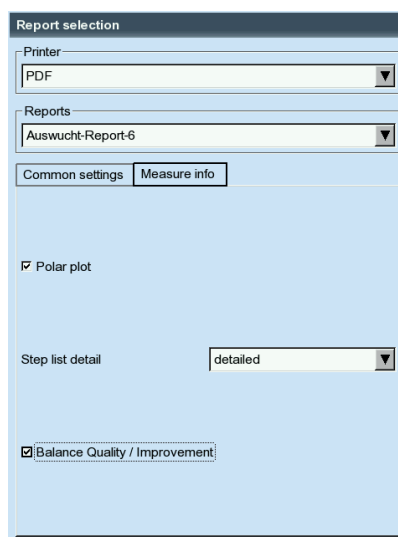

Balancing report

Prüftechnik Condition Monitoring GmbH		PRUFTECHNIK																															
Dateiname: U.staav Gedruckt am: 25.11.2008 08:22:14 Gemessen am: 25.11.2008 07:53:43																																	
Messaufgabe: user Aufnehmer Setup: VIB 6.146																																	
Polar-Diagramm 																																	
Auswuchtschritte <table border="1"> <thead> <tr> <th>Nr.</th> <th>Masse [g]</th> <th>Winkel [°]</th> <th>Schwing. [mm/s]</th> <th>Winkel [°]</th> <th>Drehzahl [1/s]</th> </tr> </thead> <tbody> <tr> <td>0</td> <td>---</td> <td>---</td> <td>2.746</td> <td>196</td> <td>49.052</td> </tr> <tr> <td>1</td> <td>1.0</td> <td>9</td> <td>3.335</td> <td>249</td> <td>46.545</td> </tr> <tr> <td>2</td> <td>1.2</td> <td>137</td> <td>2.075</td> <td>300</td> <td>46.545</td> </tr> <tr> <td>3</td> <td>0.7</td> <td>208</td> <td>---</td> <td>---</td> <td>---</td> </tr> </tbody> </table>				Nr.	Masse [g]	Winkel [°]	Schwing. [mm/s]	Winkel [°]	Drehzahl [1/s]	0	---	---	2.746	196	49.052	1	1.0	9	3.335	249	46.545	2	1.2	137	2.075	300	46.545	3	0.7	208	---	---	---
Nr.	Masse [g]	Winkel [°]	Schwing. [mm/s]	Winkel [°]	Drehzahl [1/s]																												
0	---	---	2.746	196	49.052																												
1	1.0	9	3.335	249	46.545																												
2	1.2	137	2.075	300	46.545																												
3	0.7	208	---	---	---																												
Maschinen Info Maschinen Name: user Maschinen Drehzahl: 49.050 1/s SQL-Auswuchtgröße: 2.50 IST - Auswuchtgröße: 4.095																																	
© 2008 PRUFTECHNIK AG V2.2(3/05) 1 / 1																																	

Setup parameters

To execute the balancing procedure VIBXPERT requires different settings, which are collected in 'setup menus':

- Machine setup (see below)
- Measurement setup (see p. 4-25)
- Transducer setup (see page 3-12)

These setups are configured prior to a balancing procedure. During balancing, only certain parameters from the machine setup can be changed. These parameters can be found in the Tools menu (p. 4-15f.).

Machine setup

A 'machine setup' contains the machine data required for balancing. VIBXPERT uses these data to calculate a suitable trial weight and the residual imbalance, the centrifugal force and the attained balancing quality. In order to edit or create a machine setup, proceed as follows:

- Mark a rotor type in the selection screen (see p. 4-7).
- Press the MENU button and click on "Task manager".
- Select a user-defined task.
- Mark the "Machine setup" field.
- Press the MENU button and click on "New" or on "Edit":

The following parameters can be set:

PLANES: *One / Two*. Number of balancing planes; cannot be changed because the rotor type is selected in the selection screen.

CORRECTION MODE*: *Free / fixed location / fixed weight / meas. tape*; takes into account restrictions on the machine (fixed locations, e.g. for ventilator blades) or local circumstances (tape measure).

*This parameter can be changed in each balancing run (MENU - Tools)

Parameters in the machine setup

The screenshot shows the 'Setup Manager: Machine' dialog box. The title bar reads 'Setup Manager: Machine'. The main area is titled 'Machine setup' and contains a list of parameters with their current values or settings:

Parameter	Value / Setting
User	user
Planes	2
Correction mode A	fixed location
Correction mode B	meas tape
No. of locations A	24
Outer diameter B	150.0 mm
Trial/Trim weights	add
Balance quality	2.5
Use different radii	Yes
Radius A (Trial)	75.0 mm
Radius B (Trial)	85.0 mm
Radius A (Trim)	75.0 mm
Radius B (Trim)	85.0 mm
Rotor mass	8.00 kg
Auto trial weight	Yes
Trigger angle A	90 °
Trigger angle B	90 °

Depending on the selection, the following parameters can be set:

- No. of locations: 3-100. Usually the number of ventilator blades.
- Fixed weight: Mass of the available balancing weight.
- Outer diameter: The tape measure can be used to determine the position of the balancing weight without a reference angle (see graphic on page 4-16).

When balancing in two planes the correction mode can be set separately for each plane.

TRIAL/TRIM WEIGHTS*: *add / remove*; in general, an imbalance is corrected by affixing weights to the rotor. If this is not possible, VIBXPERT calculates how much mass must be ground off the rotor ('negative').

* This parameter can be changed in each balancing run (MENU - Tools)

BALANCE QUALITY: 0 - 4000; evaluation of the residual imbalance using quality grades according to DIN ISO 1940 (see p. 4-29). If the calculated balancing quality is smaller than the selected value, the 'smiley' symbol appears in the data screen and the balancing run is complete. Select the value "0" to work without evaluation of the residual imbalance.



The measured shaft RPM is used by default as the reference RPM for the calculation of the balance quality achieved. With the parameter 'Speed for balance quality' (see next page) you can execute the calculation of the residual imbalance in relation to an arbitrary RPM.

USE DIFFERENT RADII: *Yes / No*; the trial weights can be attached at a different radius than the balancing weights.

RADIUS: *Balancing radius*; distance of the balancing weight from the rotational axis; the larger the balancing radius, the smaller the balancing weight for the same RPM.

ROTOR MASS: The mass of the rotor is taken into consideration in the calculation of the trial weight.

AUTO TRIAL WEIGHT: *Yes / No*; VIBXPERT calculates a trial weight according to ISO 1940 and based on the balance quality, the rotor mass, the rotational speed and the balancing radius.

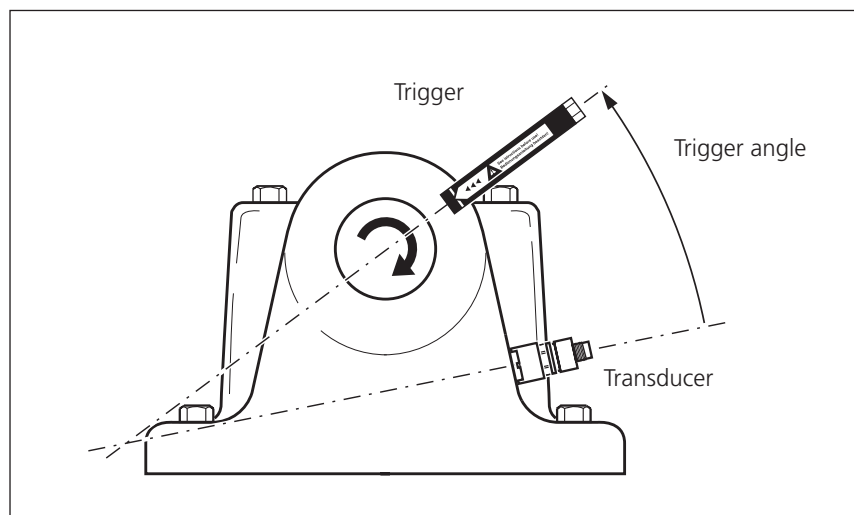

Trigger angle:

Angle between transducer and trigger is calculated counter to the direction of rotation of the rotor

Balancing: Machine setup

TRIGGER ANGLE: The angle between the sensor and the trigger sensor is taken into account in the calculation of the attachment angle for the trial weight. Convention: Angle is counted against the direction of rotation of the rotor.

SPEED FOR BALANCE QUALITY*: Reference RPM for calculation of the achieved balance grade and centrifugal force (see p. 4-18).

* This parameter can be changed in each balancing run (MENU - Tools)

CHECK SPEED*: Yes / No; see "Check functions" on page 4-17.

CONTROL 2ND PLANE: Yes / No; when balancing in one plane, the vibration in a second plane can be recorded and displayed as well (see also page 4-26).

MINIMIZE ERROR IN 2ND PLANE*: Yes / No; generally, the vibration in the control plane increases. Activate this option to calculate the balancing weights in such a way that the vibration in both the balancing plane and the control plane are minimized.

AUTO AVERAGE: Yes / No; with a strongly varying imbalance pointer, VIBXPERT automatically increases the selected number of averages in the measurement setup. This option works only in combination with the 'Check stability' option, p. 4-17.

CHECK STABILITY*: Yes / No; see "Check functions", p. 4-17.

CHECK BAD INFLUENCE*: Yes / No; see "Check functions", p. 4-17.

RECALCULATING COEFFICIENT

The coefficient for calculating the balancing weight can be taken over from the trial run (setting: "No") or from the previous balancing run (setting: "Yes"). Only available for 1-plane balancing.

FREE-RUN: Yes / No; the free-run mode abbreviates the balancing procedure. In this mode, only the measurement screen appears. The weight and the position of the balancing weights is not displayed. In the machine setup, all options that are used to calculate the balancing weights are deactivated. This mode should only be used by balancing experts.

Parameters in the machine setup

Left:
Machine setup for
2-plane balancing

Right:
Machine setup for
1-plane balancing

Machine setup	
user	user
Balance quality	2.5
Use different radii	Yes
Radius A (Trial)	75.0 mm
Radius B (Trial)	85.0 mm
Radius A (Trim)	75.0 mm
Radius B (Trim)	85.0 mm
Rotor mass	8.00 kg
Auto trial weight	Yes
Trigger angle A	90 °
Trigger angle B	90 °
Speed (bal. quality)	15.001 1/s
Check speed	Yes
Auto average	Yes
Check stable	Yes
Check bad influence	Yes
Free-run	No

Machine setup	
user	user
Trial/Trim weights	add
Balance quality	2.5
Use different radii	No
Radius A	75.0 mm
Rotor mass	8.00 kg
Auto trial weight	No
Trigger angle A	90 °
Speed (bal. quality)	Disabled
Check speed	Yes
Control 2nd plane	Yes
Min. error in 2nd plane	Yes
Auto average	Yes
Check stable	Yes
Check bad influence	Yes
Recalc coefficient	No
Free-run	No

Measurement setup

In order to edit or create a measurement setup proceed as follows:

- Mark a rotor type in the selection screen (see p. 4-7).
- Press the MENU button and click on "Task manager".
- Select a user-defined task.
- Mark the "Measurement setup" field.
- Press the MENU button and click on "New" or on "Edit":

The following parameters can be edited:

FILTER: 0.5 / 1 / 2 / 10 Hz; select "10 Hz" as the lowest frequency if the machine RPM is more than 600 RPM and the machine is placed on a soft foundation.

LOWPASS FILTER: Yes / No; To suppress high frequency noise signals, a low pass filter (1 kHz) can be activated (Yes). With 'No', the signal is processed without the low pass filter.

NO. OF MEASUREMENTS: 1 - 20; the number of measurements is automatically increased to the maximum value if the indicator shows strongly varying imbalance.

TIME SYNCHRONOUS AVERAGING: see p. 3-9

MEASUREMENT RANGE: see p. 3-9

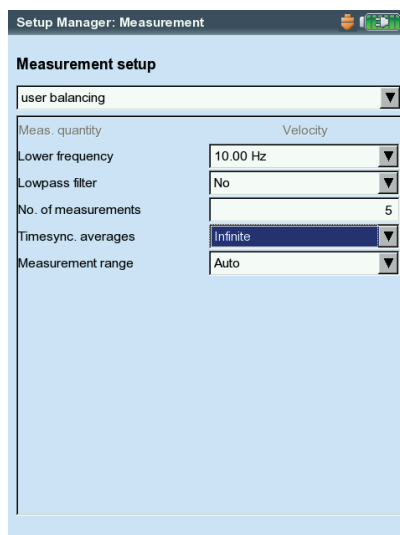

Parameters in the measurement setup

Balancing with a control plane

While balancing in one plane, the vibration pointer in a second plane - the control plane - can be recorded and displayed as well.

Activating the control plane

In the machine setup activate the 'Control 2nd plane' option (see p. 4-24 below).

Connect the transducers to the measurement channels

Connect the transducer in the *balancing plane* to the channel that is selected in the measurement task manager. Connect the transducer in the *control plane* to the other channel.

Display

In the measurement and data screen, the balancing plane is marked with a plus sign (+) (plane A in the example below).

Reducing vibration in the balancing and control planes

Vibration in the control plane generally increases with each balancing run since VIBXPERT calculates the balancing weights for the balancing plane. To reduce the vibrations in both planes as far as possible, you can include the measurement values from the control plane in the calculation of the balancing weights.

Activate 'Minimize 2nd plane error' - either in the machine setup before beginning the balancing procedure (see p. 4-24), or during balancing in the 'Tools' menu (see below).

Left:
Single plane balancing
with control plane

Right:
Minimizing the vibration in the
control plane

Balancing plane is indicated by a '+'
Control plane

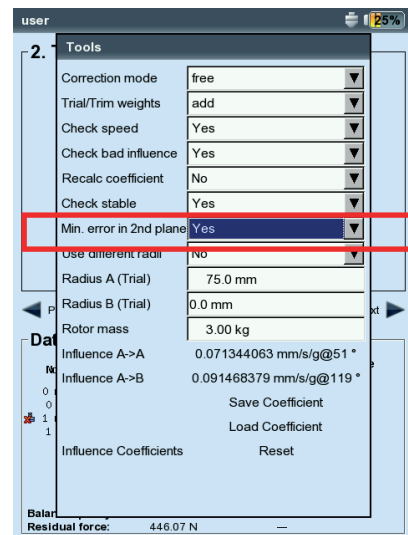
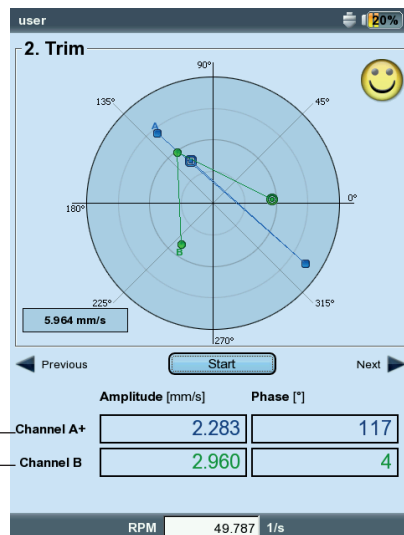

Balance calculator

With the VIBXPRT balance calculator you can convert any arrangement of balance weights on a rotor to a resulting weight.

The balance calculator operates as an independent functional module. The result cannot be saved or used in an ongoing balancing procedure.



Note

For each weight on the rotor you can configure or enter the following parameters separately:

- Correction mode
- Weight
- Position
- Balancing radius

The correction mode can be selected for the resulting weight. If parameters are changed, the calculator automatically updates the result.

Remarks

The calculator uses the balancing radius from the current machine setup for calculating the resulting weight. For the correction modes 'Fixed weight' and 'Fixed location', the values from the current machine setup are also used by default. The weights can be changed in the calculator; the number of fixed locations can only be configured in the corresponding machine setup.

In case you start the balance calculator without an active machine setup, the calculator uses the corresponding values from the machine setup 'user'.

- Change the parameters in the corresponding machine setup, if necessary.

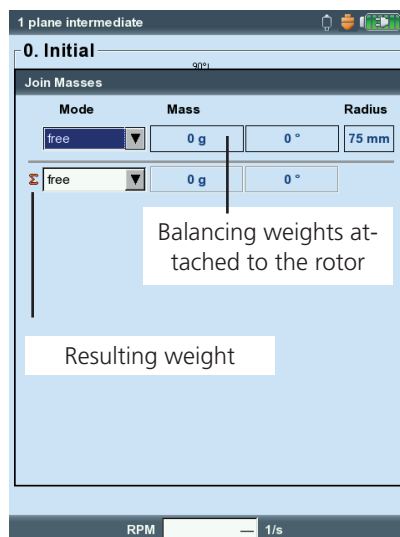
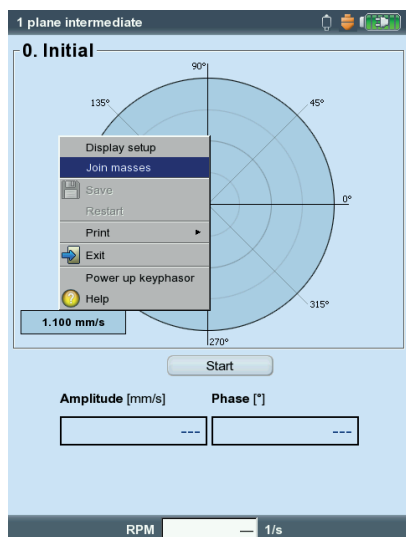

Left:
Select 'Join masses' to start
the balancing calculator

Right:
Balancing calculator

Balancing calculator

Operation of the balance calculator

The calculator can be started before or during a balancing procedure.

- Press MENU and click “.
- Press the Plus (+) key to add a new weight.



Note

In the correction modes ‘Fixed location’ and ‘Fixed weight’, two weights are possible for each line.

- Press the Minus (-) key to delete the marked weight from the list.
- Configure the required parameters for each weight in the list. Use the navigation keys to navigate within the list.
- You can select the correction mode for the resulting weight in the last line.



Note

If the resulting weight cannot be calculated in the configured correction mode, a corresponding message will be displayed. The result is then displayed for the ‘free’ mode.

* e.g. because the fixed weight in the machine setup is too small.

Left:
Result for measuring tape
correction mode

Right:
Result for fixed weight
correction mode

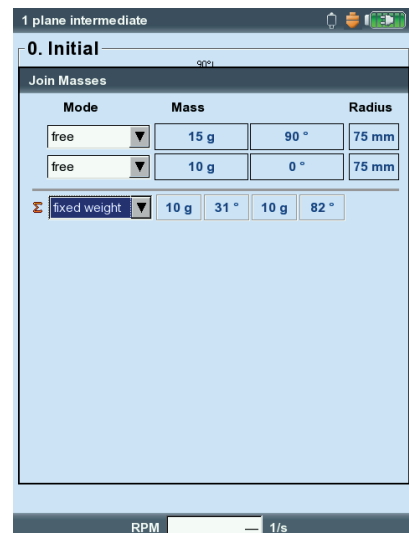
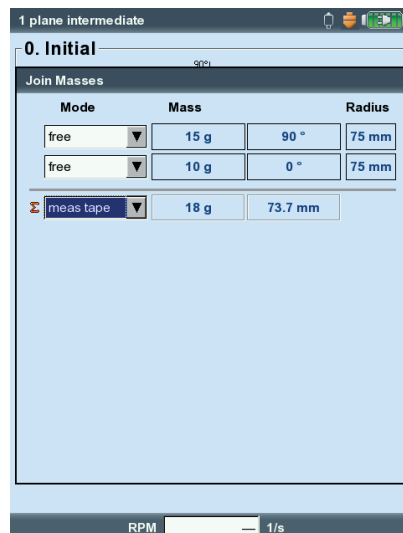

Balancing quality classes

(excerpt from DIN ISO 1940)

Qty. class	Examples of balancing bodies or machines
630	Crank gear rigidly assembled four-stroke engines and elastically mounted ships diesel engines
250	Crank gear rigidly mounted, high-speed 4-cylinder diesel engines
100	Crank gear rigidly mounted, high-speed diesel motors with six and more cylinders
40	Automobile wheels, rims, wheel sets, drive shaft crank gear elastically mounted, high-speed four-stroke engines with six and more cylinders
16	Crank gear components of automobile, truck and locomotive engines, crank gear of six and more cylinder engines with special requirements"
6.3	Fans, flywheels, centrifugal pumps, machine construction and machine tool construction parts
2.5	Impellers of jet power plants, gas and steam turbines, turbo blowers and generators
1	Tape recorder and phono drives, grinding machine drives
0.4	Precision grinding machine anchorages, shafts and disks, gyroscopes

Messages during balancing**Insufficient improvement**

The vibration values are greater than 1 mm/s and have not sufficiently improved. Check whether the cause is actually an imbalance.

One-plane balancing is recommended

The dynamic portion of the calculated imbalance is larger than the static portion. The results will not be significantly improved if you proceed to balance in two planes.

Remove balancing weight?

You can leave the balancing weight on the rotor or remove it after each balancing run. Answer the question with YES or NO.

RPM measurement

VIBXPERT measures the RPM before each balancing run. The green LED lights up if the RPM sensor sends a pulse.

Please check trigger sensor!

There is no signal from the trigger / RPM sensor. Possible causes: signal path is interrupted, poor light conditions, incorrect orientation of the trigger optics for the reference mark, ...

Initializing

The measurement amplifier is adjusted (Autorange)

Speed fluctuates. Results can be influenced!

The RPM variation is too large or deviates too much from the measured RPM of the preceding balancing run. Wait until the machine has reached the balancing RPM before starting the measurement.

Vibration pointer unstable

The magnitude and/or the phase of the vibration pointer is changing too much. VIBXPERT automatically increases the selected number of averages until the signal is stable or the maximum number of averages (20) is reached.

Maximum number of averages reached

VIBXPERT has set the number of averages to 20. If the vibration pointer has stabilized, the balancing runs can be continued.

Balancing planes cannot be separated (2-plane balancing)

The influences of the balancing weights in the other plane are the same or are adjusted so that they increase at the same time. Under these conditions, the results for the subsequent balancing runs cannot be used. Balancing in one plane is recommended.

Pointer change too large

The vibration pointer in the trial run has changed too much in magnitude and phase in comparison to the initial imbalance run.

Pointer change too small

The vibration pointer in the trial run has not changed enough in magnitude and phase in comparison to the initial imbalance run.

If the change is too large, the trial weight must be reduced. If it is too small, the trial weight must be increased.

Restart is recommended (1-plane balancing)

If the vibration values increase and the balancing weights increase from one balancing run to the next, no further improvement can be expected. The entire balance measurement must be restarted.

Masses combined.**Remove previously attached masses!**

The previously attached balancing weights are added together (vectorially) to form a single weight. Attach the weight calculated in the data screen to the rotor, and remove all previously attached balancing weights. Start the next balancing run. In comparison to the last run, the balanced state should not change substantially.

Emergency storage

If the balancing procedure is stopped prematurely (e.g. battery discharged), the data are stored in a recovery file. When the device is switched on again, the balancing procedure can be continued with the aid of this recovery file.

Opening the recovery file

- Switch on the measuring device.
- In the start screen, click on the 'Balance' symbol.
- Open the tab in which the interrupted balancing procedure was started (e.g. '1 plane').
The recovery file is labeled with a warning symbol.
- Click on the recovery file to open the recovery dialog box. It shows information on when the emergency storage took place and the number of balancing steps (see below).
- Click on 'Restore' to open the file and continue the balancing procedure, or to save the data properly.
Click on 'Discard' to clear the data in the recovery file and start a new measurement.
Use 'Exit' to leave the recovery dialog box without deleting the recovery file.



Continuing the balancing procedure after emergency storage

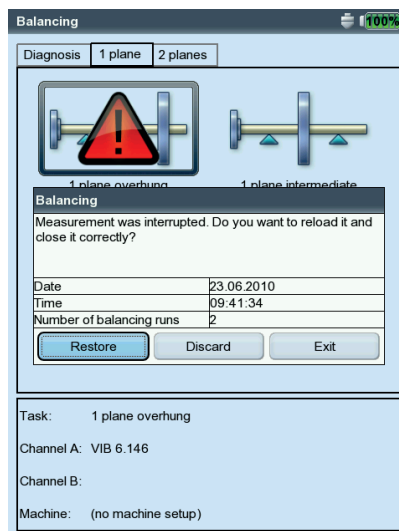

Chapter 5: Appendix

This chapter provides information on how to use

- the numerical and text editors,
- the VIBXPERT utility software,
- the File Manager

Instructions on handling and maintaining the VIBXPERT as well as the technical data complete this chapter.

Numerical editor

The numerical editor appears each time it is necessary to enter a numeric value (see below).

- To enter a numerical value, move the cursor over the character field and click on the required digit.
- To delete numerals, press the ESC key. Only the left digit of a number is deleted.
- The sign can be toggled at any time with ' \pm ' in the character field.
- Decimal places are entered as a period '.'.
- To save the value, press the MENU key and click on 'OK'.

Decimal places

Decimal places can only be entered if the 'Accuracy' of the respective quantity is not set to zero (see the section on 'Units' in the device setup, p. 2-19).

Value range

The permissible value range is defined in the 'Maximum' / 'Minimum' fields. If the value is outside of this range, the threshold that has been exceeded is displayed with a black background. In this case, the entered value cannot be saved.

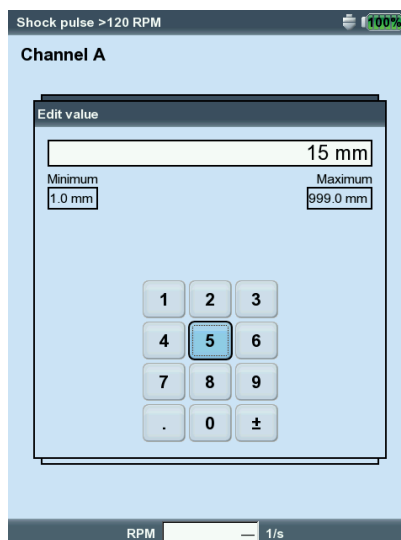

Numerical Editor

Text Editor

Entering text



- Press the F key until the cursor appears in the *character table* (see below).
- To enter the text, click on the respective characters in the table . If the required character is not included, then press the '+' key to display further character tables.
- Finally press the MENU key and click on 'OK'.
- To cancel, press the ESC key.

Deleting text

- Press the F key until the cursor appears in the *text field*.
- To delete an individual character/word:
 - Place the cursor to the right of the character/word to be deleted.
 - Press the F key to switch the cursor into the character table.
 - Click on '<=' in the character table (backspace key, see below).
- To delete a text field:
 - Press the F key until the entire text field is highlighted.
 - Click on 'Enter'.
 - Press the F key again to switch the cursor into the character table.
 - Click on '<=' in the character table (backspace key).



Note

Special characters (*Space, comma, +, /*) are not allowed in file names.

The *text defaults* field contains texts which you can accept and, if necessary, modify by clicking.

Text editor

Text defaults,
only for
- Measurement task/ Create new setup

Text field (one line or several lines)

Character table

'Backspace' key

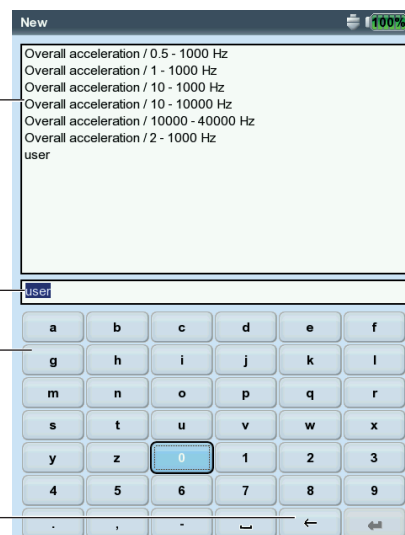

File Manager

The File Manager administrates the measurements which were saved in the 'Multimode' and 'Balancing' operating modes. In the 'PDF files' folder you will find the print files generated in the PDF format. You can print out or delete these here.

The File Manager is opened by ...

... clicking on the 'File Manager' icon in the start screen.

... selecting the 'Load file' menu option in the Multimode Measurement Task screen.

... saving a measurement result.



For opening and saving, only the files of the current measurement type are displayed (e.g. overall value - vibration acceleration). If you open the File Manager from the start screen, all files are displayed (see below).



Note

Functions of the MENU key

SAVE: Saves the measurement result.

OPEN: Opens the highlighted file

CREATE DIR: Creates a new folder

RENAME: Renames a file/folder

PRINT: Prints out a PDF file

COPY, PASTE, CUT: Copies, inserts, moves file/folder via the clipboard.

DELETE: Deletes a file/folder

SORT: Sorts files by name, by time or by type.

FIND: Searches a file/folder. Enter the complete name or the first letter of the name. Call up the search function with the F key.

F

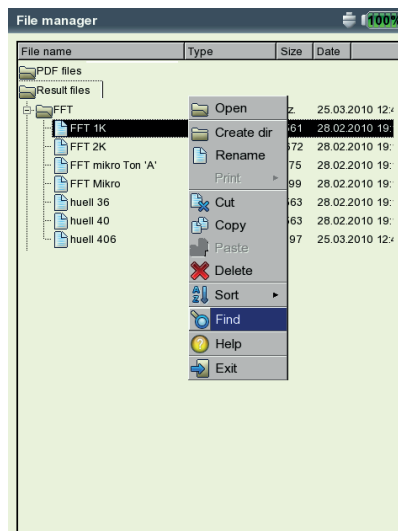
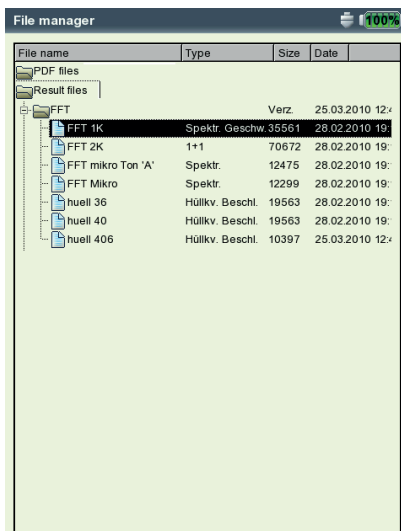

Left:
File Manager
contains result files and print files (PDF)

Right:
Search File Manager

Printing out the PDF file

The print files saved in the PDF format can be printed as follows:

- Connect VIBXPERT to a printer.
- Open the File Manager and select the file to be printed.
- Press the MENU key and select 'Print > Printer'. Printing starts.



Note

Details on connecting and setting up a printer can be found in Chapter 2 (p. 2-21).

Transferring a PDF file on a USB pendrive

See page 3-33.

Print PDF file
Select printer

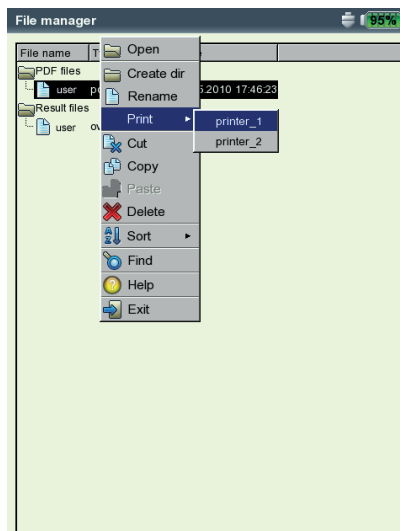

VIBXPRT utility

The 'VIBXPRT utility' tool can be used for the following tasks:

- Updating firmware (with the VIBXPRT update tool)
- Saving and restoring results and settings
- Formatting the CF memory card
- Export results in CSV format (Phase, Balancing)
- Export results into MS Excel.
- Loading screen contents onto the PC.
- Loading PDF files onto the PC.
- Converting spectra, time signals, impact tests and phase measurements to the UFF file format for evaluation in other analysis programs.
- Transferring language and help files for translation (for authorized PRÜFTECHNIK representatives only).

Installing and starting the program

The 'VIBXPRT utility' tool can be obtained from your PRÜFTECHNIK sales partner. To install the tool proceed as follows:

- Double click on the file 'VibXpert_utility_version.exe' to start the installation.
- Follow the instructions on the screen.
- To start the program, open the Windows START menu and select 'Programs / PRÜFTECHNIK Condition Monitoring / VIBXPRT utility / VIBXPRT utility'.

Alternative: In the installation directory* double click on 'vxpTool.jar'.

* C:\Programs\Pruftechnik\wibxpert\VIBXPRT utility



A start screen appears in which all available functions are accessible via buttons:



Show version number

Select language



Registration

Registering optional functions

The following functions are optional and must be enabled by a password:

- Conversion of measurement files into formats that can be processed by other analysis programs (UFF / IEEE)
- db Spectra for converting narrow band spectra to third octave spectra.
- To register, click on the 'Registration' button.
- In the screen that appears, enter the company name and, if already available, the corresponding password.
- To request a password, activate the desired function and click on 'Request registration'.

Enter password /
Request password

- In the next screen, check the entries and click on 'Print' to print out the data. Send the printout to the following fax number:
+49 89 99616300.
To send the data to PRÜFTECHNIK by eMail, click on 'eMail'.

Send / Print data for registration

- The password will be sent to you by fax or eMail within a short period of time.

Setting up a connection with VIBXPRT

Data transmission takes place via a network or USB connection.

- Connect VIBXPRT to the network or a PC using the cable provided (see also p. 2-26).
- Click on the 'Connection' button.
- Set the type of connection (USB or Ethernet).
- *For Ethernet only:* Enter the IP address of the data collector in the network in the 'IP address' field (see also p. 2-29f.).
Note: UPD port 55737 must be enabled.
- To test the connection, click on the 'Test communication' button. If the connection is working, a yellow 'Smiley' symbol appears. A red 'Smiley' symbol indicates a faulty connection.

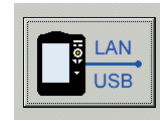

Connection

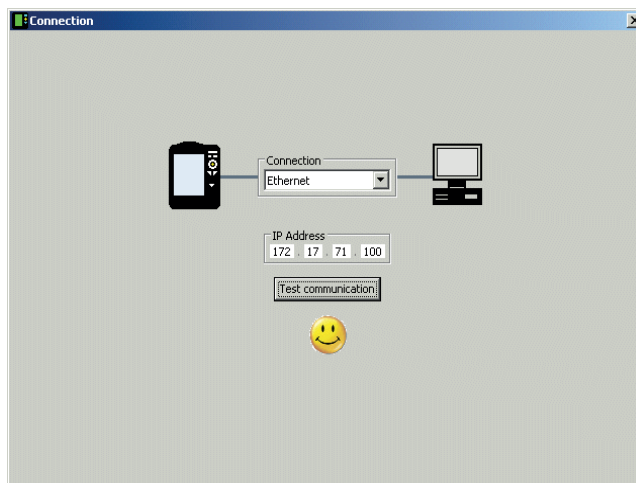

VIBXPRT successfully connected

Configuring VIBXPRT

The configuration encompasses the following functions:

- Updating the firmware
 - Transferring logo images for the report printouts
- Click on the 'Configure device' button.
 - The 'New firmware' button starts the 'VIBXPRT update tool' that updates the firmware in VIBXPRT (see also p. 2-31f.).



Device configuration



Update Firmware



Note

The program must be installed in the designated directory on the PC:
C:\Programs\Pruftechnik\vibxpert\VxpUpdateTool

- Click on 'Report-Logo' button, to load a new logo image into VIBXPRT. The logo appears on each printed report page top right. File requirements:
 - Format: PNG / Size: 186 pixel (longest side)



Report-Logo

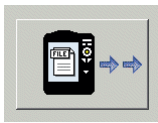

Get files



File selection window

Transferring files

The following files can be transferred from the device to the PC:

- PDF files generated with a PDF printer driver.
- Screenshots generated by pressing <F> & <-> simultaneously .
- Results in CSV format for analysis and display in a spreadsheet program (eg MS Excel).

- Click on the 'Get files' button.
- Then click on the respective button and select the files you wish to transfer.
- Click on 'Transfer' to start the file transfer.

'Export *.xls' exports results into a MS Excel file (P. 3-34).

Use 'Delete' to remove a file from the device.

'Close' closes the file selection window.

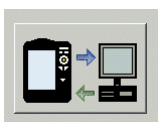
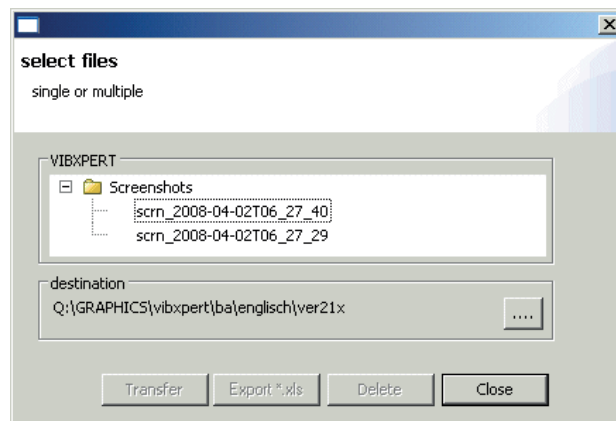

System



Backup settings

Transferring system files

You can perform the following procedures:

- Backup and restore of the data and device configuration
- Format CF memory card.
- All the above mentioned steps in a procedure ('Defragmentation').

- Click on the 'System' button.
- To perform a data backup, click on 'Backup'.
- In the screen that opens, select the data category (Settings / Results) and enter the target directory, if necessary.
- Click on 'Backup' to start the procedure.

The 'Restore' procedure is performed in the same manner.

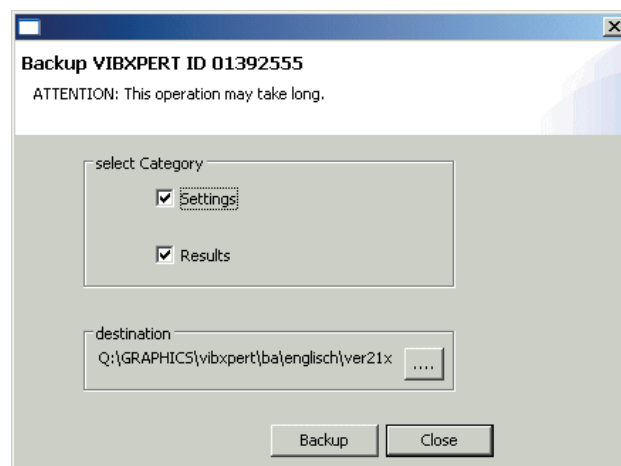

- Click on 'Format CF card' to format the memory card in the device.

Risk of data loss!

Before proceeding, make sure that all important data and settings are backed up on an external storage device. Formatting deletes all data on the memory card. The process is not reversible!

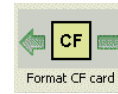
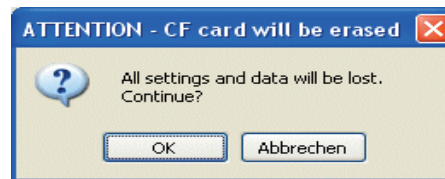

- Click on OK to start formatting.
- Click on 'Defragmentation' to perform the procedures 'Backup', 'Restore' and 'Format' in one step.



Technical notes

VIBXPERT is a precision instrument and should be treated as such.

Storage

Use the VIBXPERT carrying pouch for transporting VIBXPERT and for making on-site measurements. If VIBXPERT is not used for lengthy periods, stow the measurement instrument in the pouch and connect it regularly to the mains to avoid the battery from completely discharging.

Make sure that

- the storage location is dry
- the measurement device is not stored near electronic equipment which can generate strong electromagnetic fields.
- the measurement instrument is not exposed to temperatures above 70°C / 156°F or under -20°C / -4°F.
- the humidity is not more than 90%.

Cleaning

If lightly soiled, the carrying case and the housing can be wiped with a damp cloth. In cases of more stubborn soiling, use a household cleaner.

The display is protected against damage by a scratch-free transparent film. Use a soft dry cloth to clean the film. If necessary, the protective film can be ordered from your PRÜFTECHNIK representative.



Never use solvents or other strong cleaning agents

Maintenance

Various factors such as aging or temperature can cause an offset in the analog electronics. This offset should be compensated every two months. Details are given on page 2-23.

To guarantee the high measurement accuracy of the device, VIBXPERT requires accuracy checks every two years. The respective date is indicated on the colored sticker on the rear of the measurement instrument. A couple of months before the next accuracy check a warning will appear on the display when the instrument is switched on. Send the device to your PRÜFTECHNIK representative.

Before you send the unit in for repairs or calibration, transfer the measurement data to the OMNITREND software. Afterwards, conduct a backup. For data backup, use the program VIBXPERT utility.



For safety reasons, do not send units if the battery is obviously defective or if you suspect a defect in the battery!



Next check: November 2019

Guarantee

The measurement device has a guarantee period of 1 year. Any guarantee claims expire if service work is carried out by non-authorized personnel.

Spare parts, accessories

Only original spare parts and accessories may be used. Information on these parts is given in the VIBXPERT product catalog. The current issue can be requested free of charge from your PRÜFTECHNIK sales partner.

Disposal

Dispose of the instrument and the battery at the end of its lifetime according to the applicable environmental regulations.

For safety, cover the metal contacts of the battery with sticky tape.



Attention!

The following information applies to customers in member states of the European Union (EU) in which EU Directive

2002/96/EG "Waste Electrical and Electronic Equipment" (WEEE)

has been implemented in national law:

PRÜFTECHNIK products that fall under this directive are labeled with the symbol shown here.

What this means for you:

- All electrical and electronic PRÜFTECHNIK products and electrical and electronic accessories (e.g. cables, sensors, etc.) must henceforth be disposed of with PRÜFTECHNIK or their authorized disposal partner. Under no circumstances may these products be disposed of in household or municipal waste.
- Information on the waste disposal partner to whom you can turn when you wish to discard your equipment is available from your PRÜFTECHNIK sales partner.

PRÜFTECHNIK Condition Monitoring
WEEE-Reg.-No.: DE 72273578

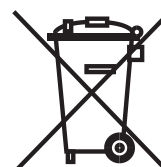

Technical data

PARAMETER		VIB 5.310
Input Channels	Analog, 2x	Voltage (AC/DC, ± 30 V max.) Current (AC/DC, ± 30 mA max.) ICP-type accelerometer (2 mA, 24 V max.) Current Linedrive (CLD) accelerometer (10 V, 10 mA max.)
	Frequency range	DC ... 51.2 kHz (Acceleration from 0.5 Hz)
	Dynamic range	96 dB (measurement) / 136 dB (total)
	Sampling frequency	up to 131 kHz per channel
	Impedance	90 kOhm, w/ cable VIB 5.433
	Analog, 1x	Thermocouple (type K)
	Digital (1+1 Pulse/ Tacho), 1x	RPM, Trigger, Keyphaser with pulse and AC signals: 0 V ... +26 V or -26 V ... 0 V
	Max. input voltage	± 26 V
	Switching threshold for 0 V ... +26 V signal	max. 2.5 V rising, min. 0.6 V falling
	Switching threshold for -26 V ... 0 V signal	min. -8 V rising, max. -10 V falling
Pulse width	< 0.1 ms	
Output Channels	Stroboscope control	TTL output
	Frequency range	0 ... 500 Hz
	Resolution	0.05 Hz
	Signal-Out	Connection for headphones to listen to the analog input signal; signal processing (oscilloscope)
	Frequency range	0.5 Hz ... 40 kHz
Output impedance	100 Ohm	
Meas. range / Accuracy	Vibration acceleration	depends on the transducer connected
	Shock pulse	-10 ... 80 dBsv / ± 3 dBsv
	RPM	10 ... 200 000 min ⁻¹ / $\pm 0.1\%$ or ± 1 min ⁻¹ (the lower accuracy is applicable)
	Temperature type K	-50 ... +1000°C / 1% or ± 1 °C (the lower accuracy is applicable)
	Standards fulfilled	Frequency response according to ISO 2954
Display	Type	TFT-LCD, backlit
	Pixel area	116 x 87 mm
	Resolution	VGA (640 x 480 pixel) with 140 ppi
	Color depth	18 bit (262144 colors)

PARAMETER		VIB 5.310
Power supply	Battery type	Li Ion rechargeable battery pack (7.3V / 5.3Ah - 37.8 Wh)
	Charging time	< 5 hours in the device or external with optional charging station
	Charger, input	110-240 V / 50-60 Hz
	Charging temperature	0°C ... +50°C
Computer	Processor	Marvell PXA320 806 MHz
	Keyboard	1 navigation pad and 7 keys (Zoom, Escape, Function, Help, Menu, On/Off); Keyboard illumination controlled by ambient light.
	Memory	Internal: 128 MB DDR RAM; Compact Flash: 2 GB ... 8 GB
	Serial interface	RS 232, <115 kBaud
	USB interface	USB 2.0
	Ethernet interface	100 Mbit (100Base T), 10 Mbit (10Base T)
Environment / General	Connectors	Analog / Digital channels: MiniSnap socket Thermocouple (type K): QLA socket; all compatible to VIBSCANNER
	Housing	ABS plastics
	Dimensions	186 x 162 x 52 mm (LxWxH)
	Weight	approx. 1.1 kg
	IP rating	IP65, dust and splash-proofed
	Temperature range	-10°C ... +60°C (Operation) -20°C ... +60°C (Storage)

Troubleshooting

Symptom:

VIBXPert will not start up. The start procedure is not executed completely, the display stops at the screen showing the LINUX penguin.

Cause: Failure in the flash memory.

Solution: Reload the firmware.

Reloading firmware

Before reloading the firmware, ensure that the following components are at hand or installed on the PC:

- VIBXPert update tool version 1.47 or higher.
- Serial cable, VIB 5.430-2 and USB-Serial adapter, VIB 5.448, if applicable.
- Ethernet cable - VIB 5.331
- Connect VIBXPert to a laptop / desktop PC as follows:
 - connect the digital interface (yellow socket) to a serial port via cable VIB 5.430-2. If no serial interface is available, then use a USB port and the additional USB serial adapter VIB 5.448.
 - connect the communication interface (green socket) to the network connector of the PC via Ethernet cable VIB 5.331.

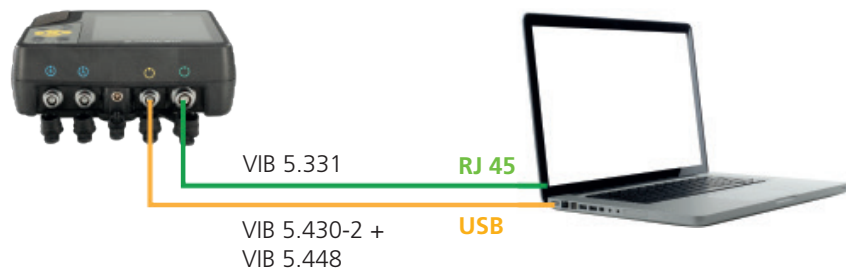

- Start the VIBXPert update tool on the PC.
- Click on the 'Start Emergency Recovery' button.

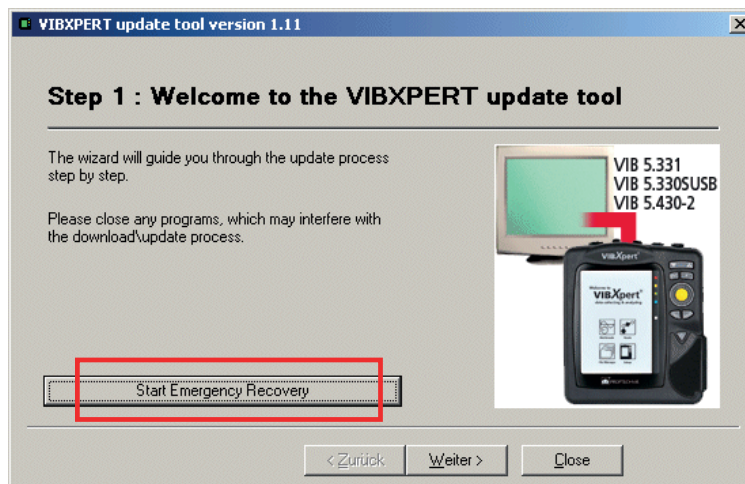

- In the next screen, set up the COM port to be used on the PC.
- Enter the IP address that is to be used by VIBXPART.
'Local IP address' appears only if the PC has access to more than one network (virtual or physical). In this case, specify the IP address of the PC to be used for communication with VIBXPART.

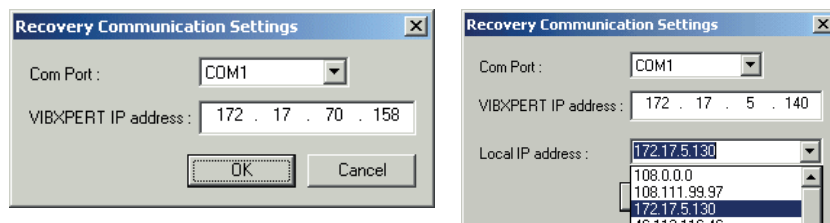

- Click on OK.
- Switch VIBXPART off and on again.
The update tool subsequently contacts VIBXPART and starts transfer of the basic firmware. The progress of the data transfer is shown in the right pane: 'Transferring data X%'

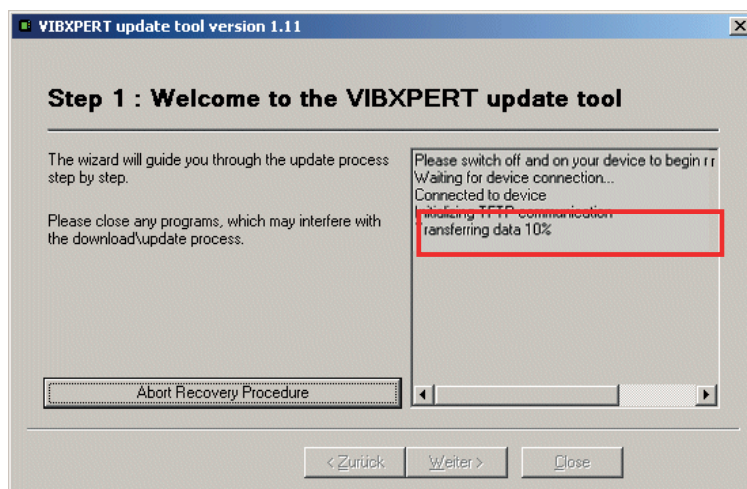

- Then it is only necessary to load the firmware: To do this, follow the instructions on Page 2-30.

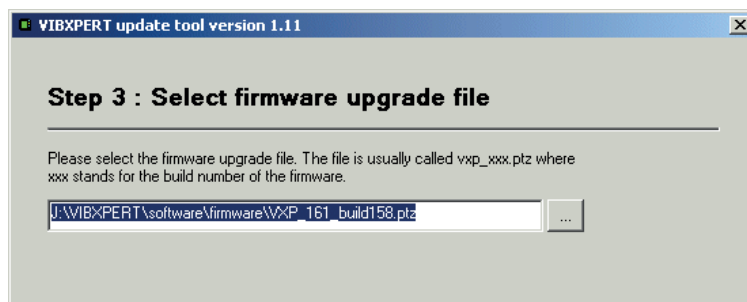

Index

Symbole

3D display 3-23

A

Accessories 5-11
 Amplitude spectrum 3-23
 Assembly 4-3
 Auto average 4-24
 Auto trial weight 4-23
 Average overlap 3-9
 Averaging type 3-8

B

Balance calculator 4-27
 Balance quality 4-23
 Balancing in one plane 4-7
 Balancing in two planes 4-11
 Balancing radius 4-18
 Balancing report 4-21
 Basic settings 2-12
 Battery icon, display 2-7
 Belt 2-9
 Bode plot 3-40

C

Carrying pouch 2-9
 Changing the meas. channel 3-5
 Charger 2-7
 Charging station, external 2-8
 Check bad influence 4-17
 Check speed 4-17
 Check stability 4-17
 Circular plot 3-19
 Cleaning
 VIBXPRT 5-10
 Coastdown 3-38
 Combining balancing weights 4-14
 Communication 2-6, 2-28
 Connection to PC 2-26
 Continuous measurement 3-27
 Continuous phase 3-29
 Control 2nd plane 4-24
 Control plane 4-26
 Correction mode 4-15, 4-22
 Couple imbalance 4-1
 Crest factor 3-35
 Cursor 3-18, 3-20, 3-22, 3-28, 3-29

D

Data View 4-13
 Date 2-12
 Daylight saving 2-12
 dB scaling 2-25
 Default vibration sensor 2-16
 Delete files 2-25, 5-3
 Demo 2-24
 Demodulation factor 3-11
 Device Info 2-23
 Device Setup 2-12
 Display 2-13

Protective film 2-13
 Display mode 3-28
 Display setup 4-20
 Disposal 5-11
 Dynamic imbalance 4-1

E

Editor
 number 5-1
 text 5-2
 Emergency storage 4-32
 Envelope analysis 3-43
 Evaluation
 overall values 3-13
 timewaveform 3-13
 Event 3-14
 External charging station 2-8

F

Factory Defaults 2-23
 File Manager 5-3
 Filter 4-25
 Filter - HP/LP 3-11
 Filter Type 3-11
 Find 5-3
 Find peak 3-21
 Firmware, re-installing 5-14
 Fixed location 4-15
 Fixed weight 4-16
 Formatting 2-25
 Free-run 4-24
 Frequency, upper/lower 3-8

G

Getting started 2-1
 Guarantee 5-11

H

Hand strap 2-9
 Harmonics cursor 3-22
 HP/LP Filter 3-11

I

Imbalance 4-1
 Impact test 3-45
 Independent values
 Phase trend 3-29
 Influence coefficient 4-18
 Initial imbalance 4-8
 Input voltage range 3-12
 Interfaces 2-5
 ISO 1940 4-29
 ISO 10816-3 3-35

J

Join masses 4-28

K

Keyboard 2-2

Key controls 2-20
 Keyphaser 2-17

L

Language 2-18
 Laser trigger sensor 4-4
 Laser-trigger sensor 3-36
 LED indicators 2-2
 Linear from / to 3-12
 Lines 3-11
 Live mode 3-3, 3-27
 LogLevel 2-24
 Lowpass filter 4-25

M

Machine setup 4-22
 Maintenance 5-10
 Measurement 3-3
 abort 3-5
 channel, changing 3-5
 quantity 3-12
 range 3-10
 rate 3-42
 repeat 3-5
 report 3-31
 task 3-2, 3-35
 manager 3-6
 new 3-6
 user-defined 3-43
 time 3-8, 3-11
 type 3-8
 Measurement range 4-25
 Measurement setup 4-25
 Measuring tape 4-16
 Memory card 2-10, 2-25
 Minimize error in 2nd plane 4-24

N

Nameplates 1-12
 Negative average 3-10, 3-46
 Network communication 2-28
 Network connection 2-27
 No. of measurements 4-25
 Number editor 5-1
 Number of lines 3-11
 Nyquist diagram 3-41

O

Octave 3-25
 Offset 3-12
 Offset Compensation 2-23
 Options - Measurement 3-5
 Order 3-9
 Order filter 3-44
 Order scaling 3-28
 Overall value 3-16
 calculating 3-19
 Display setup 3-27
 Overall vibration 3-35
 Overlap 3-9

P

Parameters
 Evaluation 3-13
 Measurement setup 3-8
 RPM measurement 3-13
 transducer 2-14
 Patch connection 2-26
 Peak, find 3-21
 Phase measurement 3-44
 Phase trend 3-44
 Plot type 3-29
 Post-Processing 3-21
 Power supply 2-7
 Printer 2-21
 Protective display film 2-13
 Pulse per rev. 3-9

R

Radius 4-23
 Recalculating coefficient 4-24
 Rechargeable battery 2-7
 Reference edge 2-17
 Registration 2-18
 Removing the balancing weight 4-17
 Repair CF card 2-25
 Report 4-21
 Measurement 3-31
 Report-Logo 5-7
 Resonance frequency 3-12
 Result
 Details 3-16
 RMS, show 3-21
 Rotor mass 4-18, 4-23
 RPM deviation 3-42
 RPM range 3-11
 RS 232 2-26
 Runup / Coastdown 3-38

S

Safety 1-10
 Sampling rate 3-8
 Save 2-20, 3-4, 5-3
 Scaling 3-18
 Screenshot 3-30, 4-21
 Search 5-3
 Sensor check 2-16
 Serial connection 2-26
 Service addresses 1-9
 Service menu 2-23
 Settling time 3-12
 Setup
 new 3-6
 Sidebands 3-19, 3-22
 Signal
 Display-Setup 3-29
 Signal type 3-12
 Sound spectrum 3-25
 Spare parts 5-11
 Spectrum 3-23
 Speed for balance quality 4-18, 4-24

Speed Marker 3-28
 Start measurement
 Multimode 3-3
 Start-Stop, RPM
 Runup/ coastdown 3-10
 Static imbalance 4-1
 Status display - LED 2-2
 Storage 5-10
 Stroboscope 3-21
 Subharmonics 3-22
 Switching on 2-3
 Symbols 1-10

T

Technical notes 5-10
 Temperature meas. 3-37
 Text editor 5-2
 Third-octave 3-25
 Time 2-12
 Time format 2-12
 Time signal 3-18
 Time-synchronous average 3-9, 4-25
 Time zone 2-12
 Transducer
 new 2-15
 Parameter 2-14
 used in 2-14
 Trend 3-29
 Display-Setup 3-29
 measurement 3-15
 Trial run 4-8
 Trial/Trim weights 4-23
 Trigger 3-10
 Trigger angle 4-24
 Trigger sensor 3-36, 4-4
 Trim run 4-9
 Troubleshooting 5-14

U

Undoing balancing runs 4-10
 Units 2-19
 Update 2-30
 USB connection 2-26
 USB pen drive 2-27, 3-33
 Use different radii 4-23

V

VIBXPRT
 Technical notes 5-10
 VIBXPRT PC license 2-18
 VIBXPRT utility 5-5

W

Waterfall diagram 3-23
 WEEE 5-11
 Window 3-11

Z

Zoom 3-18, 3-28

Productive maintenance technology

Fluke Deutschland GmbH
Freisinger Str. 34
85737 Ismaning, Germany
+ 49 89 99616-0
www.pruftechnik.com

Printed in Germany LIT 53.203.12.2019.0G